

Feed Escapements

01/30/2025



info@cesehsa.com.mx

cesehsa.com.mx



Feed Escapements

01/30/2025

This catalog is a custom document and the products included is based on your unique selection from portions of complete catalogs that already exist. Please refer to our full catalogs for more information on products not included in this customized document.

Table of Contents

Feed Escapements

GR-ESC-1



Feed Escapements

01/30/2025

Table of Contents (continued)

FEED ESCAPEMENTS

Grippers, Rotates, and Linear Slide Solutions

	Model	Stroke Range	Thrust Range	Operating Environment	Special Features	Page GR-ESC-#
RFE		16-32mm [0.625-1.25 in]	111N - 400 N [25 lbs - 90 lbs]	IP54	Conveying part accumulator, part separator and staging. Failsafe finger locking	3
RN		16-32mm [0.625-1.25 in]	111N - 400 N [25 lbs - 90 lbs]	IP54	In-line part ejector and part staging. Conveying part accumulator or part separator.	7

FEED ESCAPEMENTS

Product Overview



Global Automation Solutions

DESTACO's Robohand products are engineered for reliability and long life to ensure maximum production uptime. These products are designed and machined for precise repeatability with minimal maintenance.



destaco.com

End Effectors | Grippers | Indexers | Manual Clamps | Power Clamps | Remote Handling

RFE SERIES

Feed Escapements | Features and Benefits | How To Order | Technical Specifications

Features:

- Sequential Part feeding with automatic finger locking mechanism
- Non-rotating square shaft maintains proper finger alignment
- Sealed design with adjustable retract stops
- Only one finger can be retracted at any time
- Unit can be mounted using top, bottom or face surface

Applications:

- Part separation, part staging
- Conveying timing operations

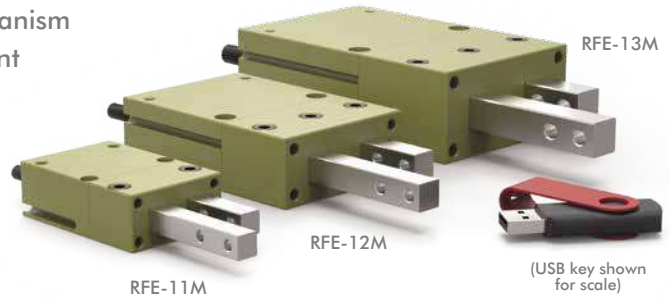

How To Order

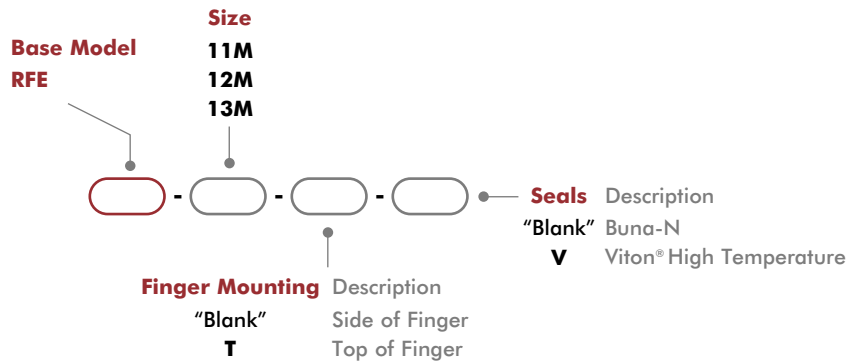

Accessories

Sensor Accessories	Model Numbers	Part Number	Qty/Unit
NPN Hall Effect Sensor with Quick Disconnect*	All Models	OHSN-017	1-2
PNP Hall Effect Sensor with Quick Disconnect*	All Models	OHSP-017	1-2
Quick Disconnect 2 Meter Cable Length*	All Models	CABL-010	1-2
Quick Disconnect 5 Meter Cable Length*	All Models	CABL-013	1-2

Pneumatic Accessories	Model Numbers	Part Number	Qty/Unit
M5 Adjustable Flow Control	All Models	VLVF-008	1-2

*Sensor and cable sold separately.

Specifications

Specifications	Units	11M	12M	13M
Thrust Force @ Maximum PSI	N [lbs]	111 [25]	222 [50]	400 [90]
Stroke	mm [in]	15.88 [0.625]	25.40 [1.000]	31.75 [1.250]
Stroke Adjustability	mm [in]	11 [0.44]	19 [0.75]	19 [0.75]
Weight	kg [lb]	0.15 [0.33]	0.39 [0.85]	0.83 [1.84]
Pressure Range	bar [psi]	3-7 [40-100]		
Cylinder Bore Ø	mm [in]	14.30 [0.563]	20 [0.787]	27 [1.063]
Rod Ø	mm [in]	6.35 [0.250]	7.95 [0.313]	9.52 [0.375]
Displacement	cm ³ [in ³]	2.6 [0.156]	8.0 [0.487]	18.2 [1.108]
Temperature Range (Buna-N seals)	°C [°F]	-35~80° [-30~180°]		
Temperature Range (Viton® seals)	°C [°F]	-30~150° [-20~300°]		
Actuation	sec	0.40	0.60	0.70
Parts Escaped per Minute		150	100	85
Valve to Actuate		4-way, 2-position		

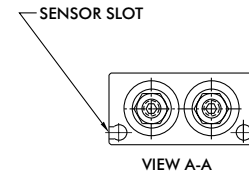
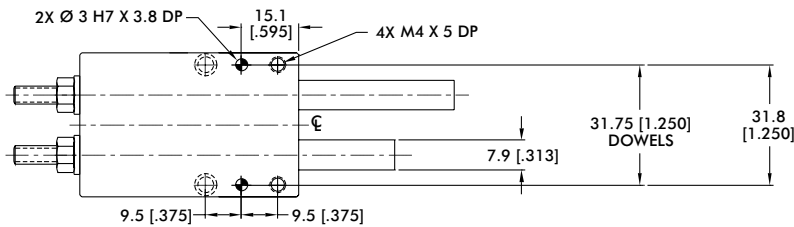
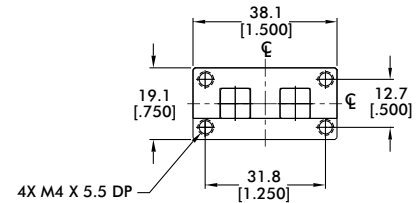
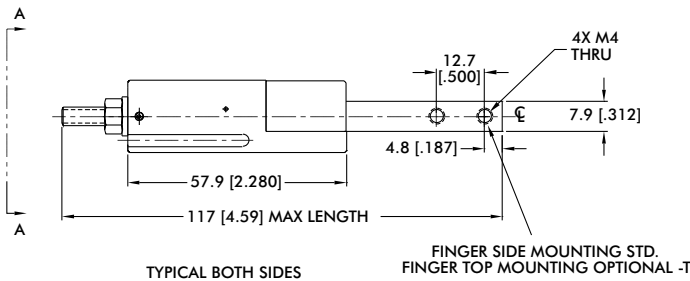
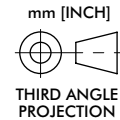
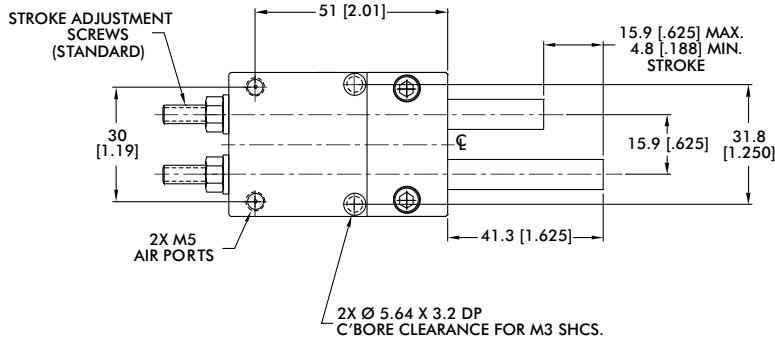

Seal Repair Kits	Order #
Buna-N Seal Repair Kit	SLKT-110
Viton® Seal Repair Kit	SLKT-110V

Loading Information

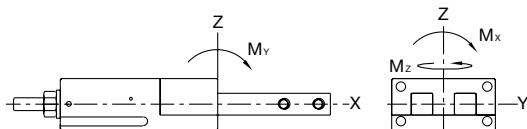

RFE-11M	Static
Maximum Moment M_x	6 Nm [50 in-lbs]
Maximum Moment M_y	6 Nm [50 in-lbs]
Maximum Moment M_z	6 Nm [50 in-lbs]

Cylinder Thrust Force

RFE-11M	Static
Thrust Force @ 7 bar [100psi]	111 N [25 lbs]
Thrust Force @ 5.5 bar [80 psi]	88 N [25 lbs]
Thrust Force @ 4 bar [60 psi]	66 N [15 lbs]
Thrust Force @ 2.7 bar [40 psi]	44 N [10 lbs]
Thrust Force @ 1.4 bar [20 psi]	22 N [5 lbs]

RFE-12M

Feed Escapements | Dimensions and Technical Specifications

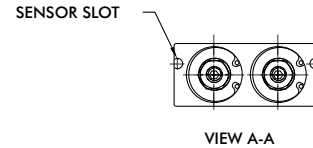
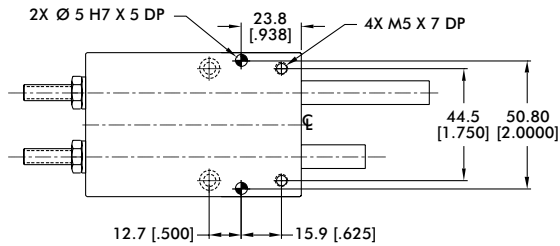
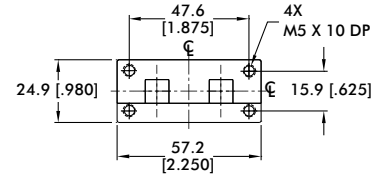
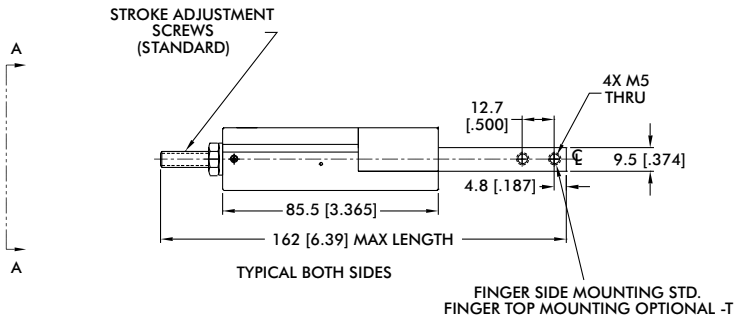
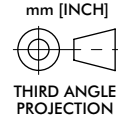
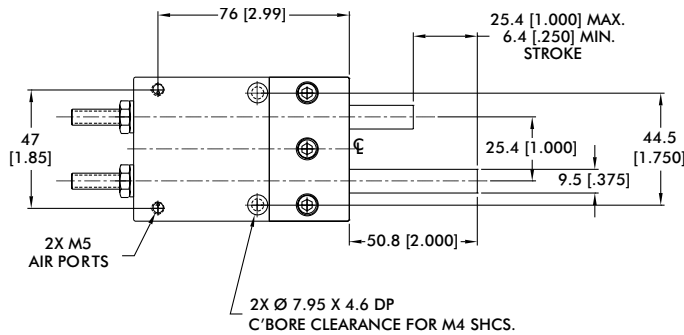

Seal Repair Kits	Order #
Buna-N Seal Repair Kit	SLKT-111
Viton® Seal Repair Kit	SLKT-111V

Loading Information

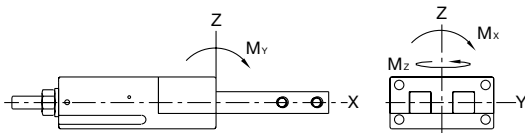

RFE-12M	Static
Maximum Moment M_x	17 Nm [150 in-lbs]
Maximum Moment M_y	17 Nm [150 in-lbs]
Maximum Moment M_z	17 Nm [150 in-lbs]

Cylinder Thrust Force

RFE-12M	Static
Thrust Force @ 7 bar [100psi]	216 N [50 lbs]
Thrust Force @ 5.5 bar [80 psi]	173 N [40 lbs]
Thrust Force @ 4 bar [60 psi]	130 N [30 lbs]
Thrust Force @ 2.7 bar [40 psi]	86 N [20 lbs]
Thrust Force @ 1.4 bar [20 psi]	43 N [10 lbs]

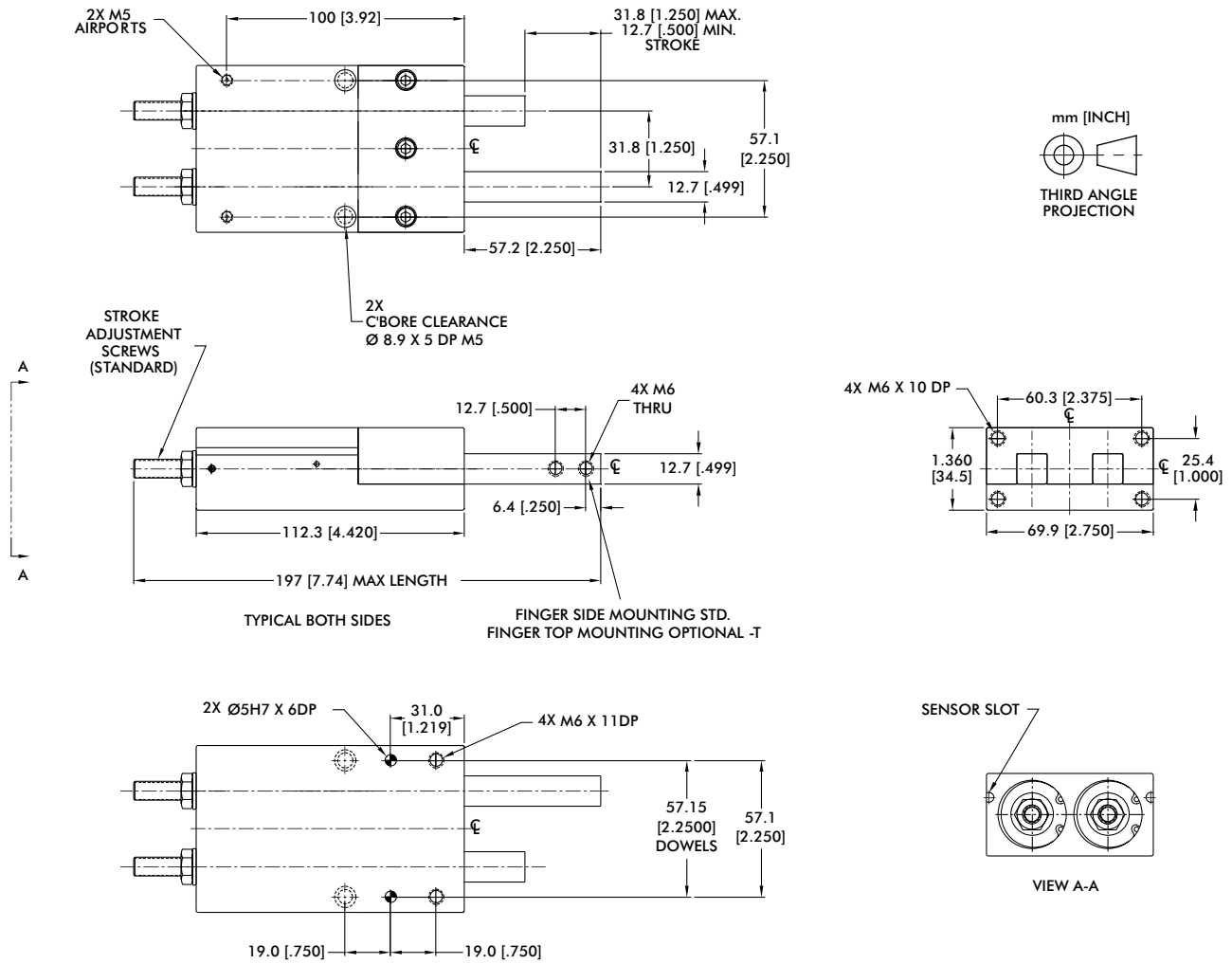

Seal Repair Kits	Order #
Buna-N Seal Repair Kit	SLKT-112
Viton® Seal Repair Kit	SLKT-112V

Loading Information

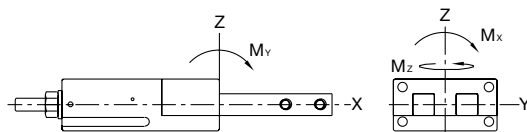

RFE-13M	Static
Maximum Moment M_x	28 Nm [250 in-lbs]
Maximum Moment M_y	28 Nm [250 in-lbs]
Maximum Moment M_z	28 Nm [250 in-lbs]

Cylinder Thrust Force

RFE-13M	Static
Thrust Force @ 7 bar [100psi]	394 N [88 lbs]
Thrust Force @ 5.5 bar [80 psi]	315 N [71 lbs]
Thrust Force @ 4 bar [60 psi]	236 N [53 lbs]
Thrust Force @ 2.7 bar [40 psi]	157 N [35 lbs]
Thrust Force @ 1.4 bar [20 psi]	78 N [17 lbs]

RN SERIES

Feed Escapements | Features and Benefits | How To Order | Technical Specifications

Features:

- Non-rotating square shaft maintains proper finger alignment
- Sealed design with adjustable retract stops
- Use independent or in tandem with other RN units
- Use in small load thruster applications
- Unit can be mounted using top, bottom or face surface

Applications:

- Conveying part separator
- Part quality ejector
- Feeder track overload guarding

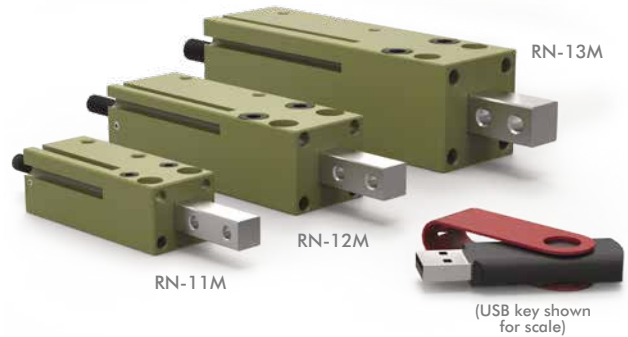

How To Order

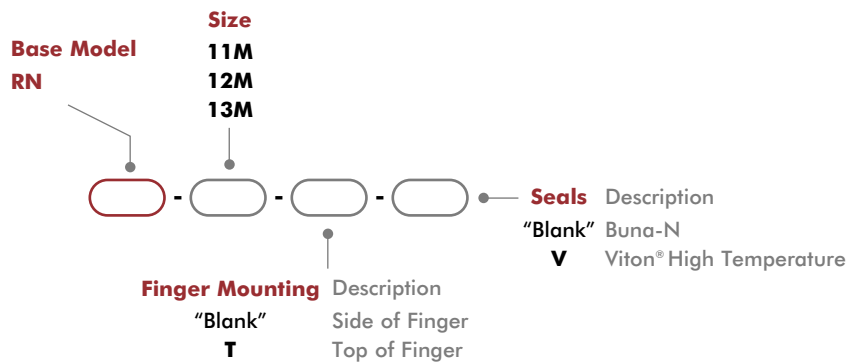

Accessories

Sensor Accessories	Model Numbers	Part Number	Qty/Unit
NPN Hall Effect Sensor with Quick Disconnect*	All Models	OHSN-006	1-2
PNP Hall Effect Sensor with Quick Disconnect*	All Models	OHSP-006	1-2
Quick Disconnect 2 Meter Cable Length*	All Models	CABL-010	1-2
Quick Disconnect 5 Meter Cable Length*	All Models	CABL-013	1-2

Pneumatic Accessories	Model Numbers	Part Number	Qty/Unit
M5 Adjustable Flow Control	All Models	VLVF-008	1-2

*Sensor and cable sold separately.

Specifications

Specifications	Units	11M	12M	13M
Thrust Force @ Maximum PSI	N [lbs]	111 [25]	222 [50]	400 [90]
Stroke	mm [in]	15.88 [0.625]	25.40 [1.000]	31.75 [1.250]
Stroke Adjustability	mm [in]	11 [0.44]	19 [0.75]	19 [0.75]
Weight	kg [lb]	0.09 [0.19]	0.19 [0.42]	0.41 [0.90]
Pressure Range	bar [psi]	3-7 [40-100]		
Cylinder Bore Ø	mm [in]	14.30 [0.563]	20 [0.787]	27 [1.063]
Rod Ø	mm [in]	6.35 [0.250]	7.95 [0.313]	9.52 [0.375]
Displacement	cm ³ [in ³]	1.3 [0.078]	4.0 [0.224]	9.1 [0.554]
Temperature Range (Buna-N seals)	°C [°F]	-35°~80° [-30°~180°]		
Temperature Range (Viton® seals)	°C [°F]	-30°~150° [-20°~300°]		
Actuation	sec	0.14	0.21	0.28
Valve to Actuate		4-way, 2-position		

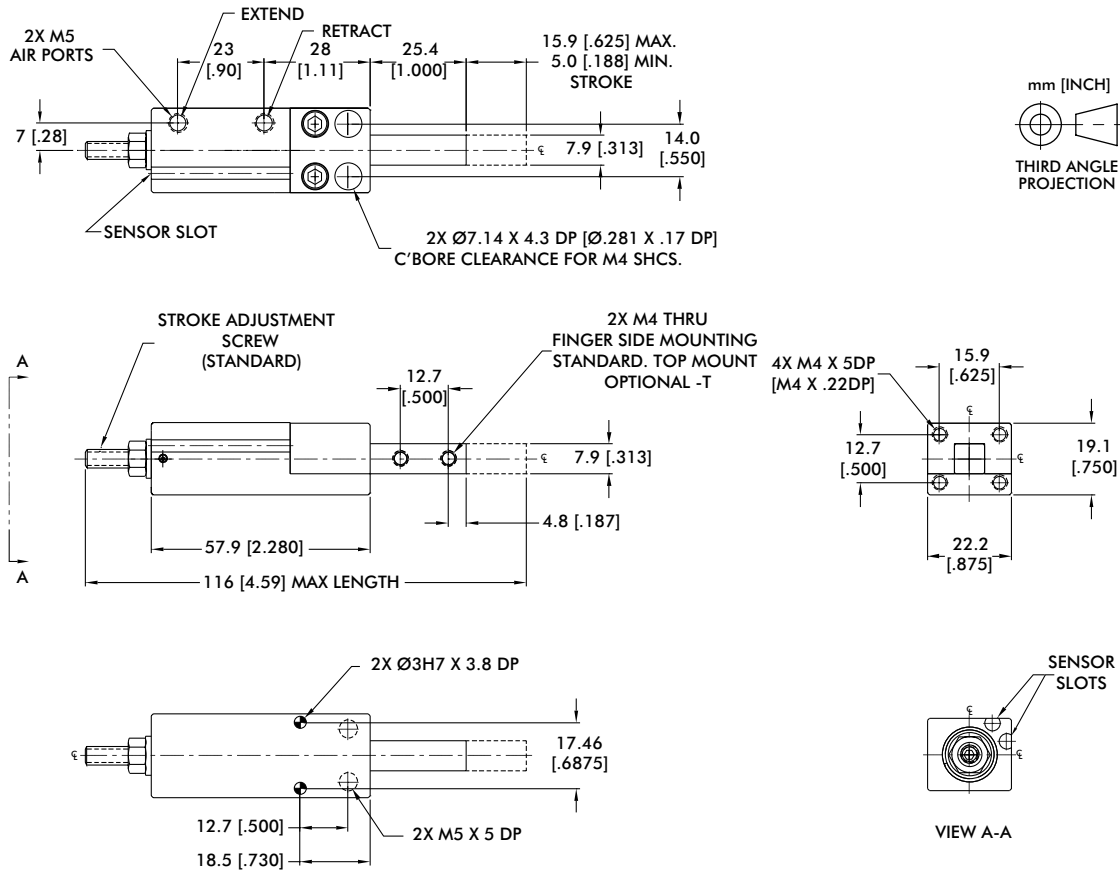

Seal Repair Kits	Order #
Buna-N Seal Repair Kit	SLKT-114
Viton® Seal Repair Kit	SLKT-114V

Loading Information

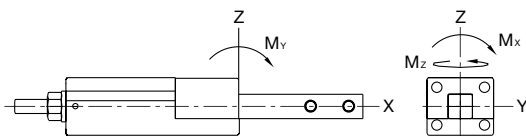

RN-11M	Static
Maximum Moment M_x	[50 in-lbs] 6 Nm
Maximum Moment M_y	[50 in-lbs] 6 Nm
Maximum Moment M_z	[50 in-lbs] 6 Nm

Cylinder Thrust Force

RN-11M	Extend	Retract
Thrust Force @ 7 bar [100psi]	111 N [25 lbs]	89 N [20 lbs]
Thrust Force @ 5.5 bar [80 psi]	88 N [20 lbs]	71 N [16 lbs]
Thrust Force @ 4 bar [60 psi]	66 N [15 lbs]	53 N [12 lbs]
Thrust Force @ 2.7 bar [40 psi]	44 N [10 lbs]	35 N [8 lbs]
Thrust Force @ 1.4 bar [20 psi]	22 N [5 lbs]	18 N [4 lbs]

RN-12M

Feed Escapements | Dimensions and Technical Specifications

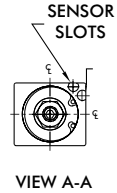
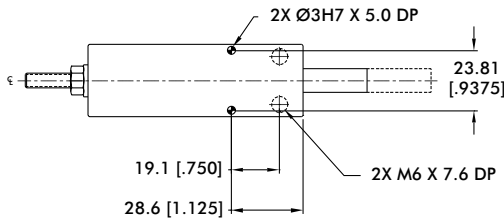
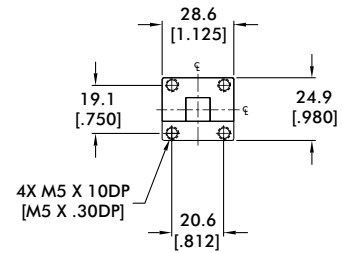
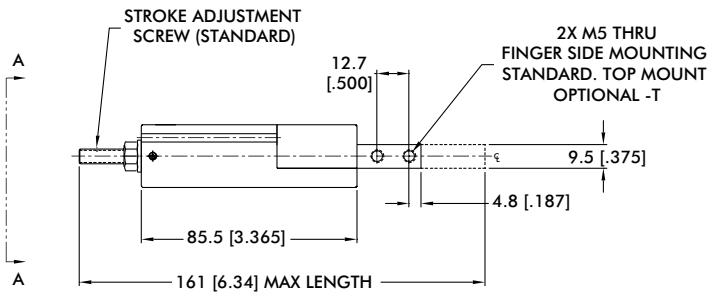
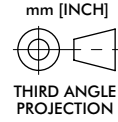
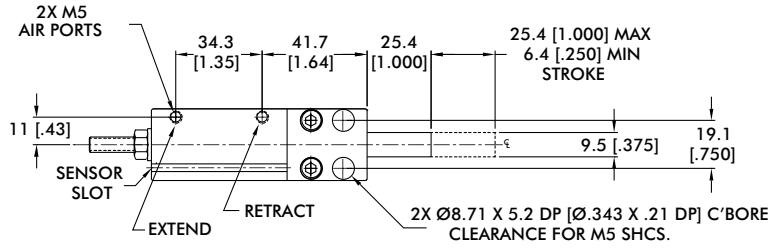

Seal Repair Kits	Order #
Buna-N Seal Repair Kit	SLKT-115
Viton® Seal Repair Kit	SLKT-115V

Loading Information

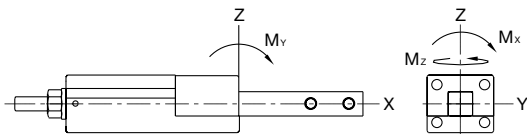

RN-12M	Static
Maximum Moment M_x	17 Nm [150 in-lbs]
Maximum Moment M_y	17 Nm [150 in-lbs]
Maximum Moment M_z	17 Nm [150 in-lbs]

Cylinder Thrust Force

RN-12M	Extend	Retract
Thrust Force @ 7 bar	217 N [49 lbs]	182 N [41 lbs]
Thrust Force @ 5.5 bar	173 N [39 lbs]	146 N [33 lbs]
Thrust Force @ 4 bar	130 N [29 lbs]	110 N [24 lbs]
Thrust Force @ 2.7 bar	87 N [19 lbs]	73 N [16 lbs]
Thrust Force @ 1.4 bar	43 N [10 lbs]	36 N [8 lbs]

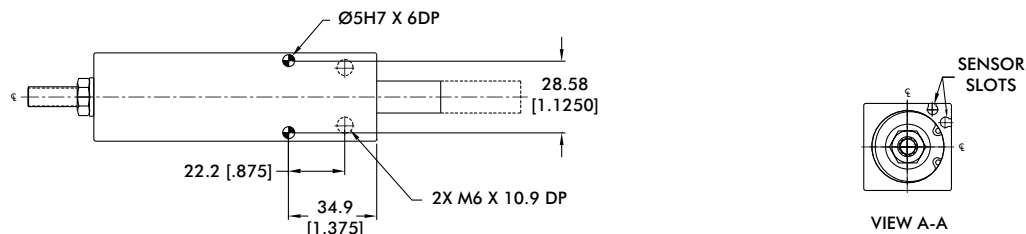
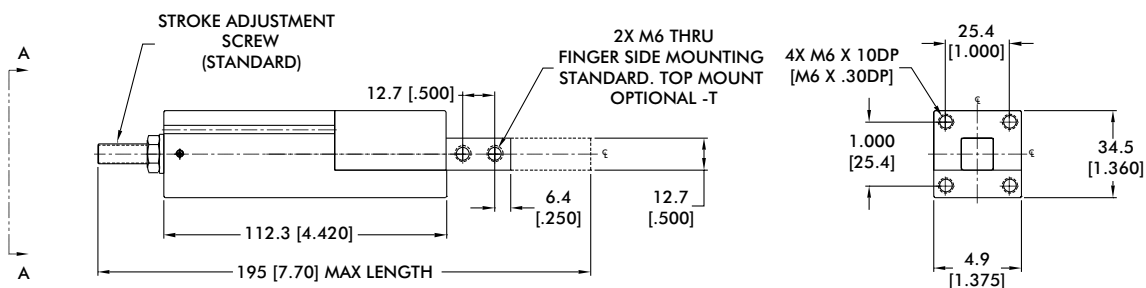
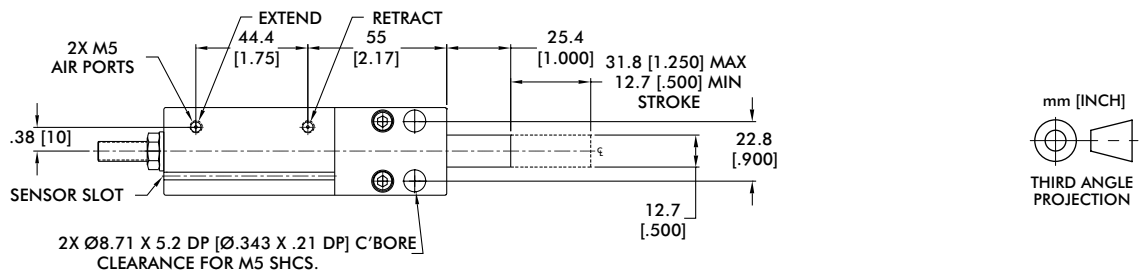

Seal Repair Kits	Order #
Buna-N Seal Repair Kit	SLKT-116
Viton® Seal Repair Kit	SLKT-116V

Loading Information

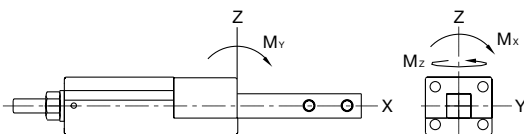

RN-13M	Static
Maximum Moment M_x	28 Nm [250 in-lbs]
Maximum Moment M_y	28 Nm [250 in-lbs]
Maximum Moment M_z	28 Nm [250 in-lbs]

Cylinder Thrust Force

RN-13M	Extend	Retract
Thrust Force @ 7 bar	394 N [88 lbs]	345 N [77 lbs]
Thrust Force @ 5.5 bar	315 N [71 lbs]	276 N [62 lbs]
Thrust Force @ 4 bar	236 N [53 lbs]	207 N [46 lbs]
Thrust Force @ 2.7 bar	157 N [35 lbs]	138 N [31 lbs]
Thrust Force @ 1.4 bar	78 N [18 lbs]	69 N [15 lbs]

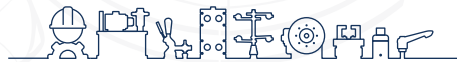

inf @ /CESEHSA.com.mx

