

# 670, 675, 690, 695 SERIES

## Straight Line Action Clamps | Product Overview

### Features:

- Precision clamping for high production
- Adjustable collet-type bushing minimizes radial plunger movement
- Plunger has a flat surface for anti rotation
- Pre-load nut and hold open device included

### Applications:

- Assembly
- Welding

670-1MBPLS



675-1MBPLS



690-1MBPLS



695-1MBPLS ⓘ



## Series 670, 675, 690, 695 Technical Information | Holding Capacities

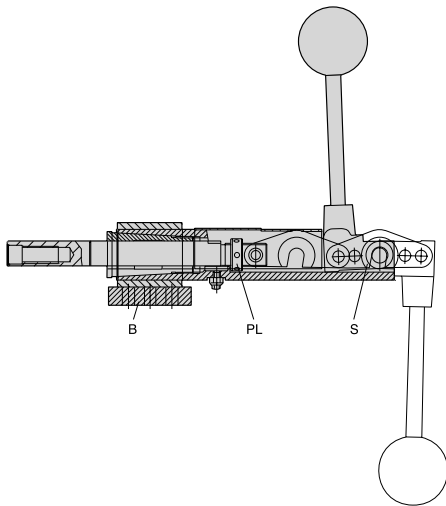

Model	Max. Holding Capacity	Weight	Plunger Travel	Plunger Thread
670-1MBPLS	[2400 lbf] 10680 N	[4.2 lb] 1,91 kg	[2.25] 57,2	M12
675-1MBPLS		[4.0 lb] 1,81 kg	[1.10] 28	
690-1MBPLS	[5000 lbf] 22240 N	[8.2 lb] 3,72 kg	[3.00] 76,2	M16
695-1MBPLS ⓘ		[7.2 lb] 3,27 kg	[1.50] 38,1	

ⓘ This item is available upon request

The unique feature of these clamps is the collet-type bushing that can be adjusted to eliminate plunger end movement after long repeated use. The plunger also has a flat which prevents lateral movement and allows offset piloting and holding. The plunger is drilled and tapped for threaded spindles or custom fixturing.

The adjustable pre-load nut (PL) can be used to lock the clamp against itself when not under pressure and therefore prevent opening when mounted vertically. The spring hold-open device (S) prevents the clamp from accidentally closing.

The mounting base (B) is supplied disassembled with the four models, to enable welding the base and the main assembly in any handle position.

Series 675 and 695 (shorter stroke) reach the over-center position only when clamping. Series 670 and 690 (longer stroke) lock in both the extended and retracted position.

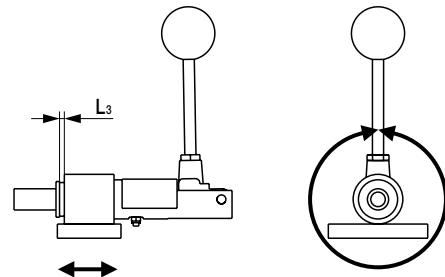

Welding range  $L_3$  axial  
0-8mm [0-0.31 in.]

Welding range  
radial 360°

# 670, 675, 690, 695 SERIES

## Straight Line Action Clamps | Dimensions

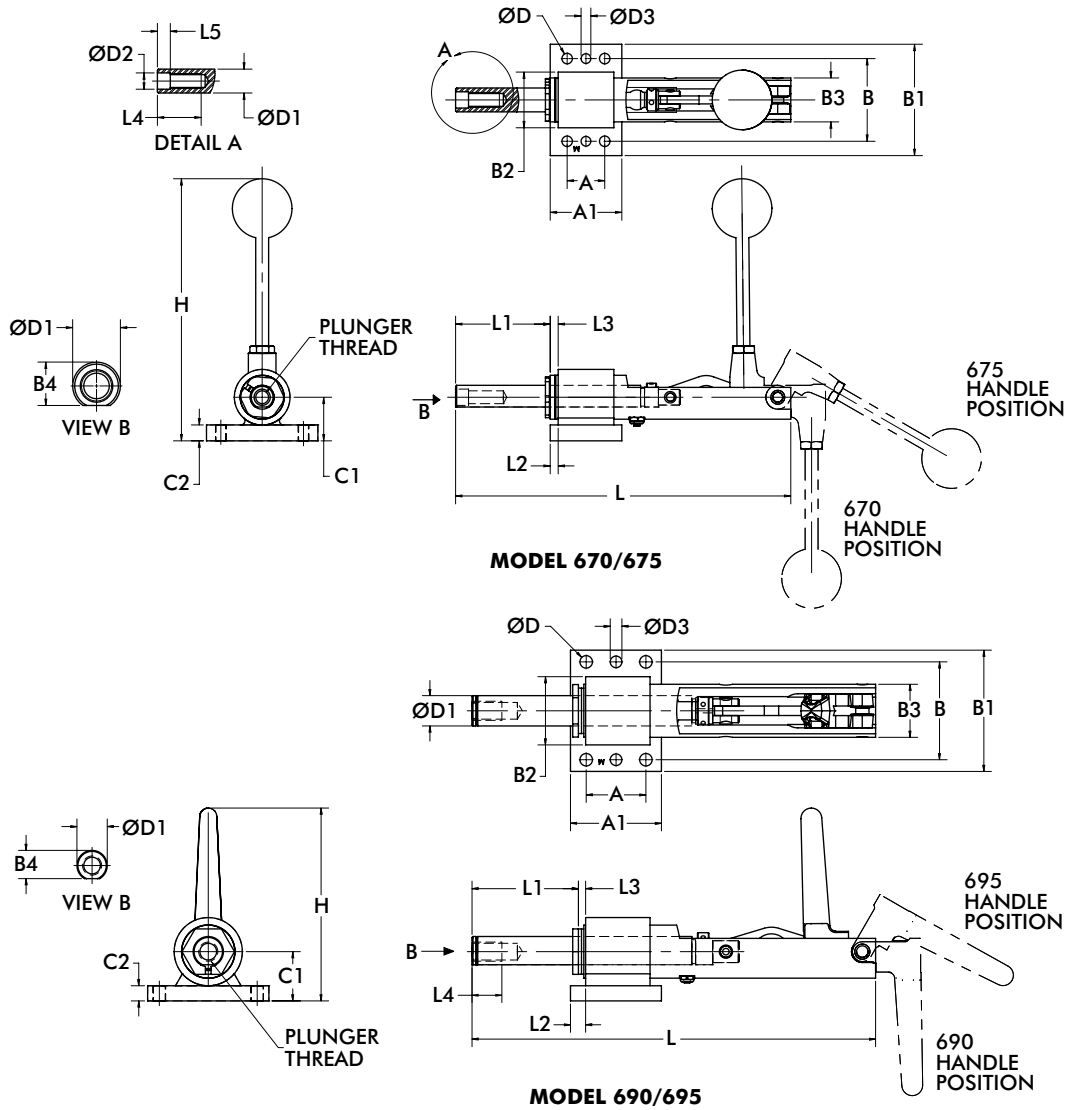

Model	A	A1	B	B1	B2	B3	B4	C1	C2	D	D1	D2H7	D3
670-1MBPLS	[1.18]	[2.24]	[2.60]	[3.50]	[1.75]	[1.38]	[0.68]	[1.37]	[0.50]	[0.33]	[0.75]	[0.51]	[0.31]
675-1MBPLS	30	57	66	89	44,5	35	17,3	34,8	12,7	8,4	19	13	7,8
690-1MBPLS	[1.97]	[3.00]	[3.23]	[4.00]	[2.25]	[1.75]	[0.93]	[1.63]	[0.50]	[0.41]	[1.00]	--	[0.39]
695-1MBPLS	50	76,2	82	101,6	57,2	44,4	23,7	41,3	12,7	10,5	25,4	--	9,8

Model	H	L	L1	L2	L3	L4	L5
670-1MBPLS	[8.11]	[10.55]	[2.97]	[0.25]	[0-0.31]	[1.38]	[0.41]
675-1MBPLS	206	[7.68]	[1.74]	6,4	0-8	35	10,3
690-1MBPLS	[6.37]	[13.31]	[3.69]	[0.50]	[0-0.31]	[0.98]	--
695-1MBPLS	162	[9.45]	[2.25]	[0.38]	0-8	25	--

# FO, FL, G SERIES



## Variable Stroke Straight Line Action Clamps | Product Overview

### FO Series

#### Type of Mounting:

- Foot mount

#### Type of Actuation:

- Hand wheel or hand lever (one-handed operation)
- Locking lever and Plunger (two-handed operation)

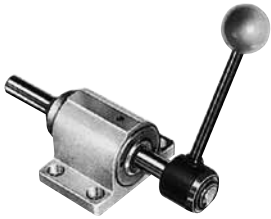

### FL Series

#### Type of Mounting:

- Flange mount

#### Type of Actuation:

- Locking lever or hand wheel (one-handed operation)
- Locking lever and Plunger (two-handed operation)

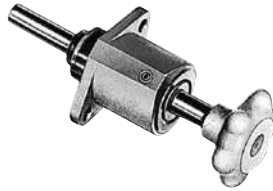

### G Series

#### Type of Mounting:









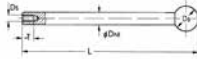

- Through hole mount

#### Type of Actuation:

- Locking lever and Plunger (two-handed operation)
- Hand wheel or hand lever (one-handed operation)

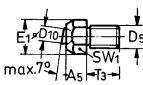

## Technical Information

		Model	Holding Capacity Max. [lbs] N	Page MC-VSC-#	Accessories	Model	Page MC-VSC-#	
Flanged base 		FO-082-40 FO-120 FO-121-45 FO-122-45	[335] 1500 [675] 3000 [675] 3000 [675] 3000	3	Plunger 	12/100 12/200 12/300 16/100 16/200 16/300 16/400 16/500 22/100 22/200 22/300	4	
		FO-160 FO-161-60 FO-162-60 FO-220 FO-221-80	[2020] 9000 [2020] 9000 [2020] 9000 [4045] 18000 [4045] 18000					
Front flange 		FL-120 FL-121-45 FL-122-45	[675] 3000		3	Swivel thrust pad 	K508 K612 K816 K1222	7
		FL-160 FL-161-60 FL-162-60	[2020] 9000					
	Threaded mount 	G-082-40 G-120	[335] 1500 [675] 3000					
		G-121-45 G-122-45	[675] 3000					
		Model	Holding Capacity Max. [lbs] N		Page MC-VSC-#			
		F-160	[4,040] 18000		3			