

2P SERIES

2-Jaw Precision Parallel Grippers | Features and Benefits | How To Order

Features:

- Robust and powerful precision multi-purpose gripper
- Pneumatic or hydraulic powered operation
- Optional tandem cylinder doubles grip force
- Protective boot and shielded design for harsh environments
- Spring assist option maintains grip in case of air pressure loss

Applications:

- Hydraulic powered gripping applications
- Confined spaces in harsh environment applications
- Welding applications with protective boot option



How To Order

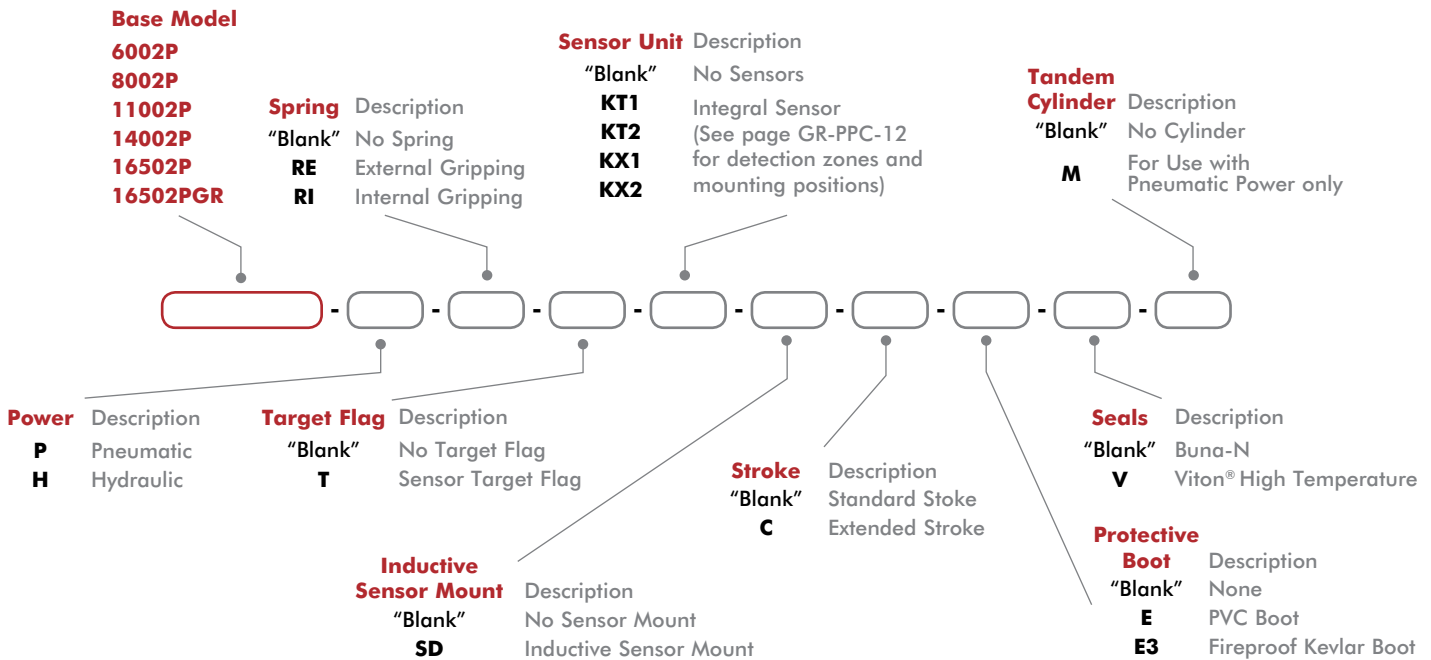

Accessories

Sensor Accessories	Model Numbers	Part Number	Qty/Unit
M8 Inductive Sensor PNP with M8 Connector	6002P, 8002P, 11002P	OISP-011-C	1-4
M8 Inductive Sensor NPN with M8 Connector	6002P, 8002P, 11002P	OISN-011-C	1-4
M8 Inductive Sensor PNP with M12 Connector	14002P, 16502P	OISP-017-C	1-4
M8 Inductive Sensor NPN with M12 Connector	14002P, 16502P	OISN-017-C	1-4
M8 Quick Disconnect 2 Meter Cable Length*	6002P, 8002P, 11002P	CABL-010	1-4
M12 Quick Disconnect 2 Meter Cable Length*	14002P, 16502P	CABL-014	1-4
Inductive Sensor Mounting Kit (1 holder + 1 flag)	6002P, 8002P	SD60-80P	1-2
Inductive Sensor Mounting Kit (1 holder + 1 flag)	11002P	SD110P	1-2
Inductive Sensor Mounting Kit (1 holder + 1 flag)	14002P	OSMK-114	1-2
Inductive Sensor Mounting Kit (1 holder + 1 flag)	16502P	OSMK-115	1-2

*Sensor and cable sold separately.

2-Jaw Precision Parallel Grippers | Technical Specifications

Specifications	Units	6002P-P	6002P-P-C	8002P-P	8002P-P-C	11002P-P	11002P-P-C
Grip Force (F6+R)1, 6 bar [87 psi], Springs Mid-Way, L=0	N [lb]	694 [156]	432 [97]	1946 [437]	1256 [282]	3043 [684]	2030 [456]
Grip Force (F0+R)2, 0 bars, Springs Mid-Way, L=0	N [lb]	176 [40]	109 [24]	635 [143]	410 [92]	965 [217]	644 [145]
Total Stroke	mm [in]	10 [0.39]	16 [0.63]	13 [0.51]	20 [0.79]	20 [0.79]	30 [1.18]
Weight	kg [lbs]	0.51 [1.12]		0.84 [1.85]		2.04 [4.50]	
Pressure Range w/o Spring	bar [psi]	2-7 [30-100]					
Pressure Range with Spring	bar [psi]	4-7 [60-100]					
Ingress Protection Class (IP)		IP54					
Displacement	cm ³ [in ³]	12 [0.73]		35 [2.14]		87 [5.31]	
Temperature Range (Buna-N seals)	°C [°F]	-35°~80° [-30°~180°]					
Temperature Range (Viton® seals)	°C [°F]	-30°~150° [-20°~300°]					
Actuation (open/close)	sec	0.07		0.08		0.10	
Repeatability	mm [in]	±0.02 [±0.001]					

Specifications	Units	14002P-P	14002P-P-C	16502P-P	16502P-P-C	1650PGR-P
Grip Force (F6+R)1, 6 bar [87 psi], Springs Mid-Way, L=0	N [lb]	6232 [1400]	4031 [906]	11475 [2579]	6878 [1546]	11475 [2579]
Grip Force (F0+R)2, 0 bars, Springs Mid-Way, L=0	N [lb]	2305 [518]	1490 [335]	3825 [860]	2292 [515]	3825 [860]
Total Stroke	mm [in]	26 [1.02]	40 [1.57]	30 [1.18]	50 [1.97]	30 [0.39]
Weight	kg [lbs]	4.2 [9.26]		8.74 [19.26]		2.04 [4.50]
Pressure Range w/o Spring	bar [psi]	2-7 Bar [30-100 psi]				
Pressure Range with Spring	bar [psi]	4-7 Bar [60-100 psi]				
Ingress Protection Class (IP)		IP54				
Displacement	cm ³ [in ³]	220 [13.43]		494 [30.15]		494 [30.15]
Temperature Range (Buna-N seals)	°C [°F]	-35°~80° [-30°~180°]				
Temperature Range (Viton® seals)	°C [°F]	-30°~150° [-20°~300°]				
Actuation (open/close)	sec	0.16		0.29		0.29
Repeatability		±0.02 [±0.001]				

6002P, 6002P-C

2-Jaw Precision Parallel Grippers | Dimensions and Technical Specifications

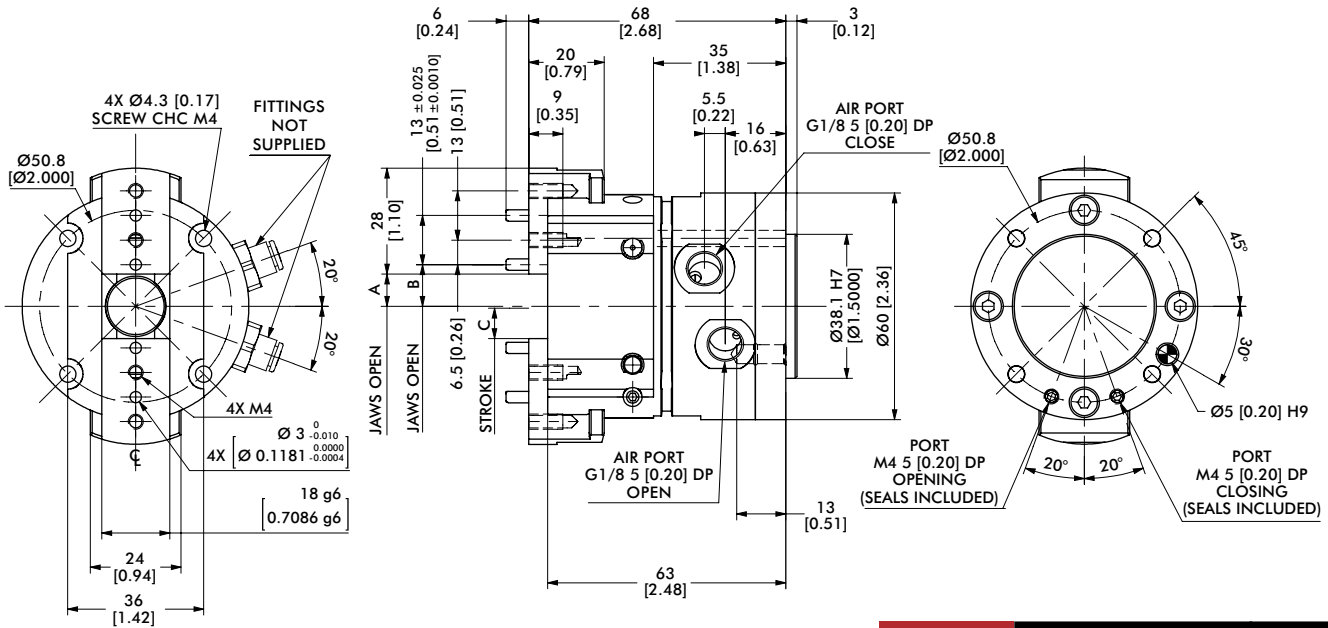

OUR GRIPPERS ARE SUPPLIED WITH OPEN SIDE AIR PORTS AND TOP AIR PORTS PLUGGED. WHEN OPERATING TOP AIR PORTS, PRODUCES MANIFOLD SEALING AS SHOWN.

GRIPPERS TOP AIR PORT
O-RING Ø1.5 X Ø4

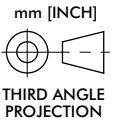

Model	A	B	C
6002P	5.5 [0.22]	8 [0.31]	5 [0.20]
6002P-C	8.5 [0.33]	11 [0.43]	8 [0.31]

Dimensions in mm [in]

Protective Boots	6002P
PVC Protective Boot, Brown or Black	ER62P
Fireproof KEVLAR Protective Boot, Red	E3R62P

Seal Repair Kits	6002P
Buna-N Seal Repair Kit	SLKT-156
Viton® Seal Repair Kit	SLKT-156V
Hydraulic Seal Repair Kit	SLKT-330

Loading Information

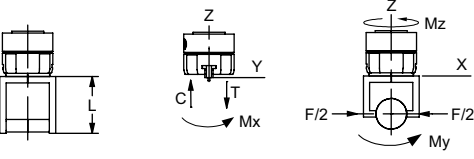
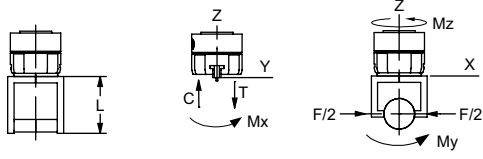
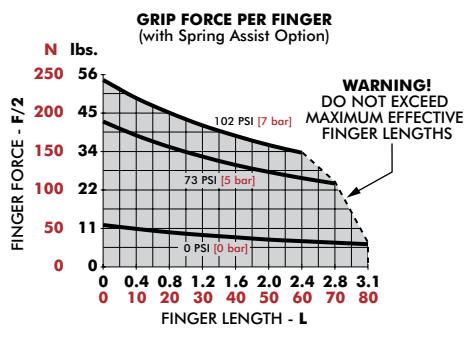
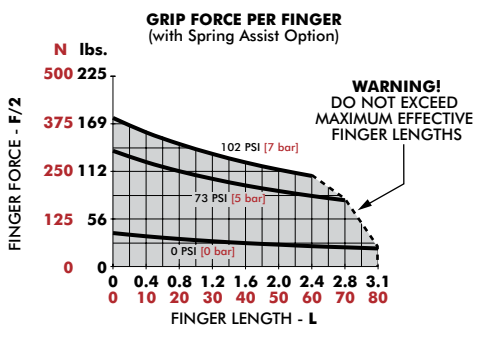

6002P	Static	Dynamic
Maximum Tensile T	410 N [92 lbs]	95 N [21 lbs]
Maximum Compressive C	780 N [175 lbs]	95 N [21 lbs]
Maximum Moment M_x	21 Nm [186 in-lbs]	3 Nm [27 in-lbs]
Maximum Moment M_y	16 Nm [142 in-lbs]	3 Nm [27 in-lbs]
Maximum Moment M_z	[239 in-lbs] 27 Nm	3 Nm [27 in-lbs]

6002P-C	Static	Dynamic
Maximum Tensile T	546 N [123 lbs]	140 N [31 lbs]
Maximum Compressive C	1037 N [233 lbs]	140 N [31 lbs]
Maximum Moment M_x	28 Nm [248 in-lbs]	4 Nm [35 in-lbs]
Maximum Moment M_y	22 Nm [195 in-lbs]	4 Nm [35 in-lbs]
Maximum Moment M_z	36 Nm [319 in-lbs]	4 Nm [35 in-lbs]

*Capacities are per set of jaws and are not simultaneous

*Capacities are per set of jaws and are not simultaneous

8002P, 8002P-C

2-Jaw Precision Parallel Grippers | Dimensions and Technical Specifications

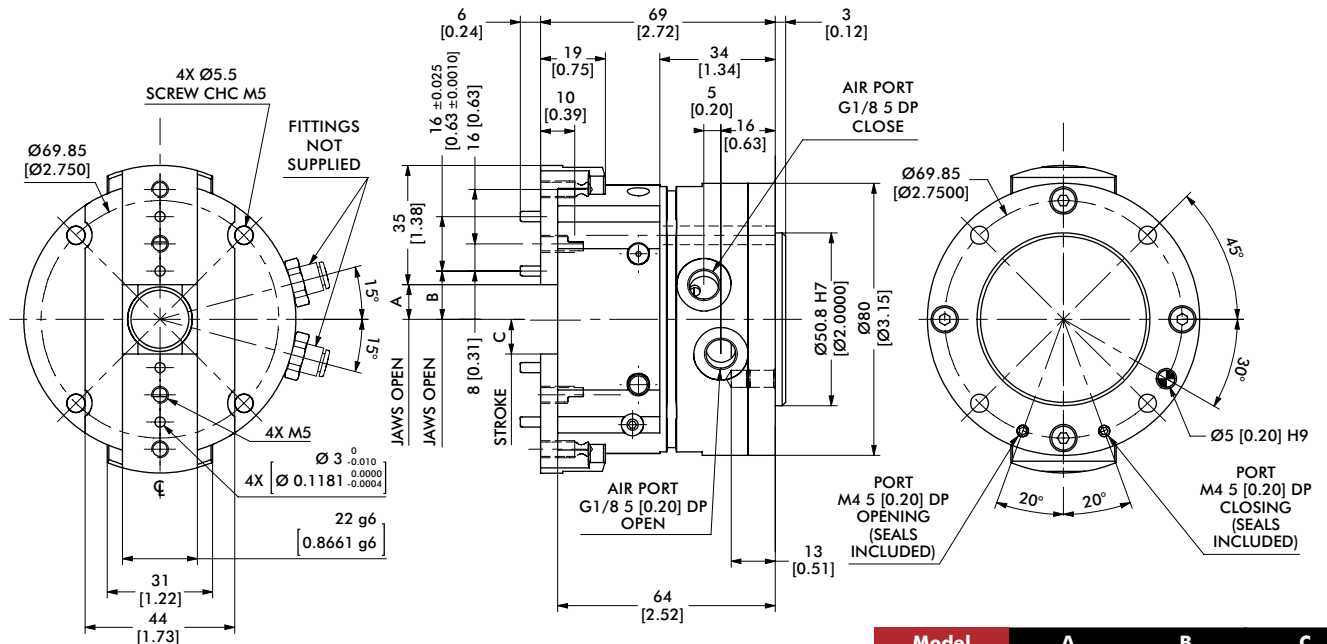

OUR GRIPPERS ARE SUPPLIED WITH OPEN SIDE AIR PORTS AND TOP AIR PORTS PLUGGED. WHEN OPERATING TOP AIR PORTS, PRODUCES MANIFOLD SEALING AS SHOWN.

GRIPPERS TOP AIR PORT

O-RING Ø1.5 X Ø4

Ø3 [Ø0.12]

Ø7 [Ø0.28]

1.2 [0.05]

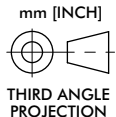

Model	A	B	C
8002P	6.8 [0.27]	10.8 [0.43]	6.5 [0.26]
8002P-C	10.2 [0.40]	14.2 [0.56]	10 [0.39]

Dimensions in mm [in]

Protective Boots	8002P
PVC Protective Boot, Brown or Black	ER82P
Fireproof KEVLAR Protective Boot, Red	E3R82P

Seal Repair Kits	8002P
Buna-N Seal Repair Kit	S80
Viton® Seal Repair Kit	S80V
Hydraulic Seal Repair Kit	S80H

Loading Information

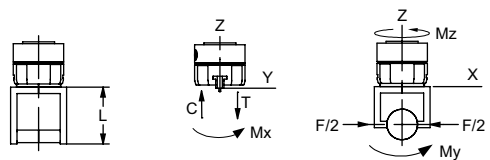
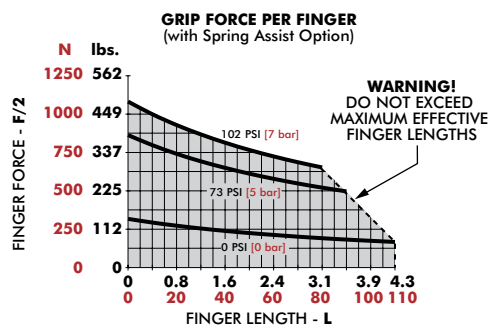

8002P	Static	Dynamic
Maximum Tensile T	819 N [184 lbs]	348 N [78 lbs]
Maximum Compressive C	1383 N [311 lbs]	348 N [78 lbs]
Maximum Moment M_x	40 Nm [354 in-lbs]	13 Nm [115 in-lbs]
Maximum Moment M_y	45 Nm [398 in-lbs]	15 Nm [133 in-lbs]
Maximum Moment M_z	25 Nm [221 in-lbs]	15 Nm [133 in-lbs]

¹Capacities are per set of jaws and are not simultaneous

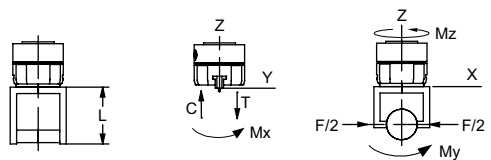
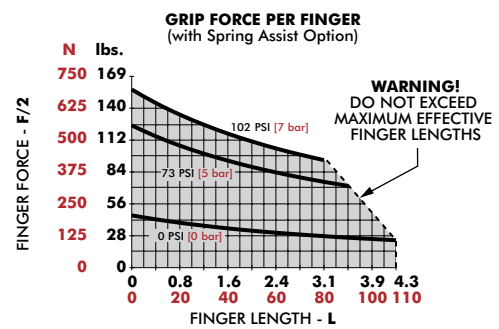

8002P-C	Static	Dynamic
Maximum Tensile T	615 N [138 lbs]	236 N [53 lbs]
Maximum Compressive C	1040 N [234 lbs]	236 N [53 lbs]
Maximum Moment M_x	30 Nm [266 in-lbs]	9 Nm [80 in-lbs]
Maximum Moment M_y	33 Nm [292 in-lbs]	10 Nm [89 in-lbs]
Maximum Moment M_z	18 Nm [159 in-lbs]	10 Nm [89 in-lbs]

¹Capacities are per set of jaws and are not simultaneous

11002P, 11002P-C

2-Jaw Precision Parallel Grippers | Dimensions and Technical Specifications

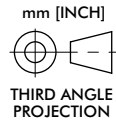
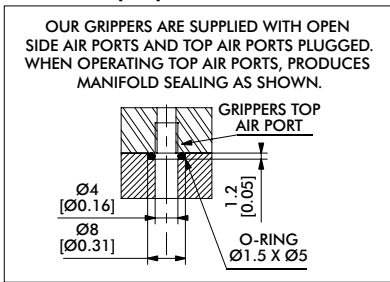
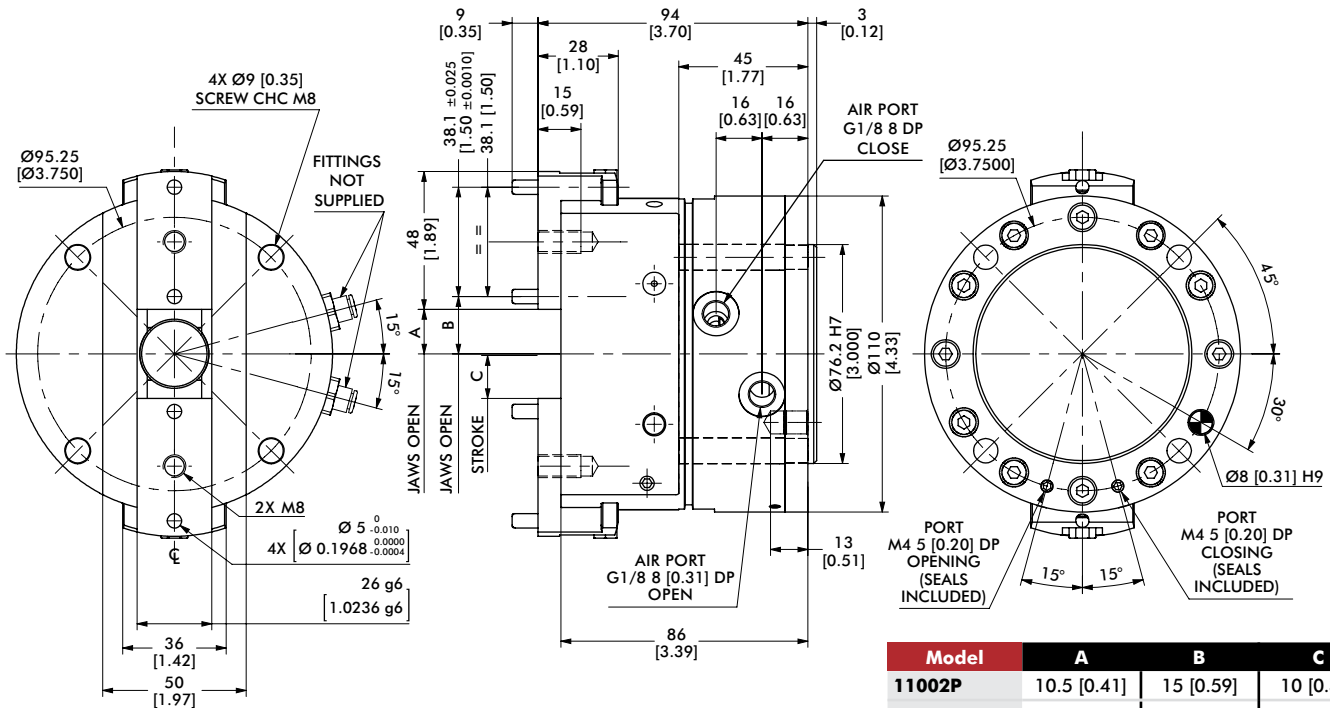

Model	A	B	C
11002P	10.5 [0.41]	15 [0.59]	10 [0.39]
11002P-C	15.5 [0.61]	20 [0.79]	15 [0.59]

Dimensions in mm [in]

Protective Boots	11002P
PVC Protective Boot, Brown or Black	ER112P
Fireproof KEVLAR Protective Boot, Red	E3R112P

Seal Repair Kits	11002P
Buna-N Seal Repair Kit	S110
Viton® Seal Repair Kit	S110V
Hydraulic Seal Repair Kit	S110H

Loading Information

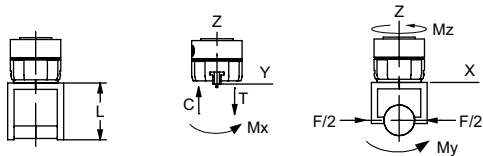
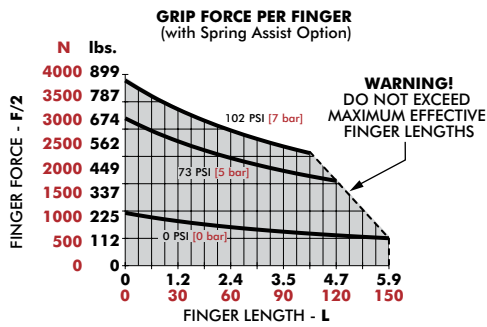

11002P	Static	Dynamic
Maximum Tensile T	1040 N [234 lbs]	556 N [125 lbs]
Maximum Compressive C	1768 N [397 lbs]	556 N [125 lbs]
Maximum Moment M_x	39 Nm [345 in-lbs]	25 Nm [221 in-lbs]
Maximum Moment M_y	53 Nm [469 in-lbs]	33 Nm [292 in-lbs]
Maximum Moment M_z	63 Nm [558 in-lbs]	33 Nm [292 in-lbs]

*Capacities are per set of jaws and are not simultaneous

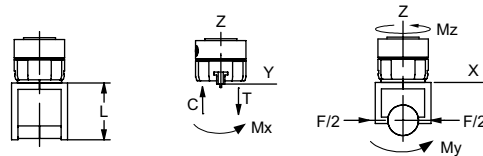
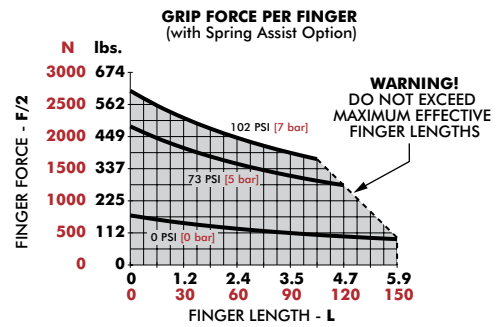

11002P-C	Static	Dynamic
Maximum Tensile T	945 N [212 lbs]	370 N [83 lbs]
Maximum Compressive C	1607 N [361 lbs]	370 N [83 lbs]
Maximum Moment M_x	35 Nm [310 in-lbs]	18 Nm [159 in-lbs]
Maximum Moment M_y	47 Nm [416 in-lbs]	24 Nm [212 in-lbs]
Maximum Moment M_z	56 Nm [496 in-lbs]	24 Nm [212 in-lbs]

*Capacities are per set of jaws and are not simultaneous

14002P, 14002P-C

2-Jaw Precision Parallel Grippers | Dimensions and Technical Specifications

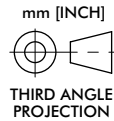
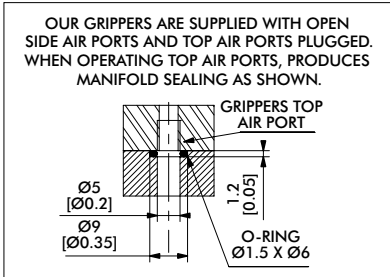
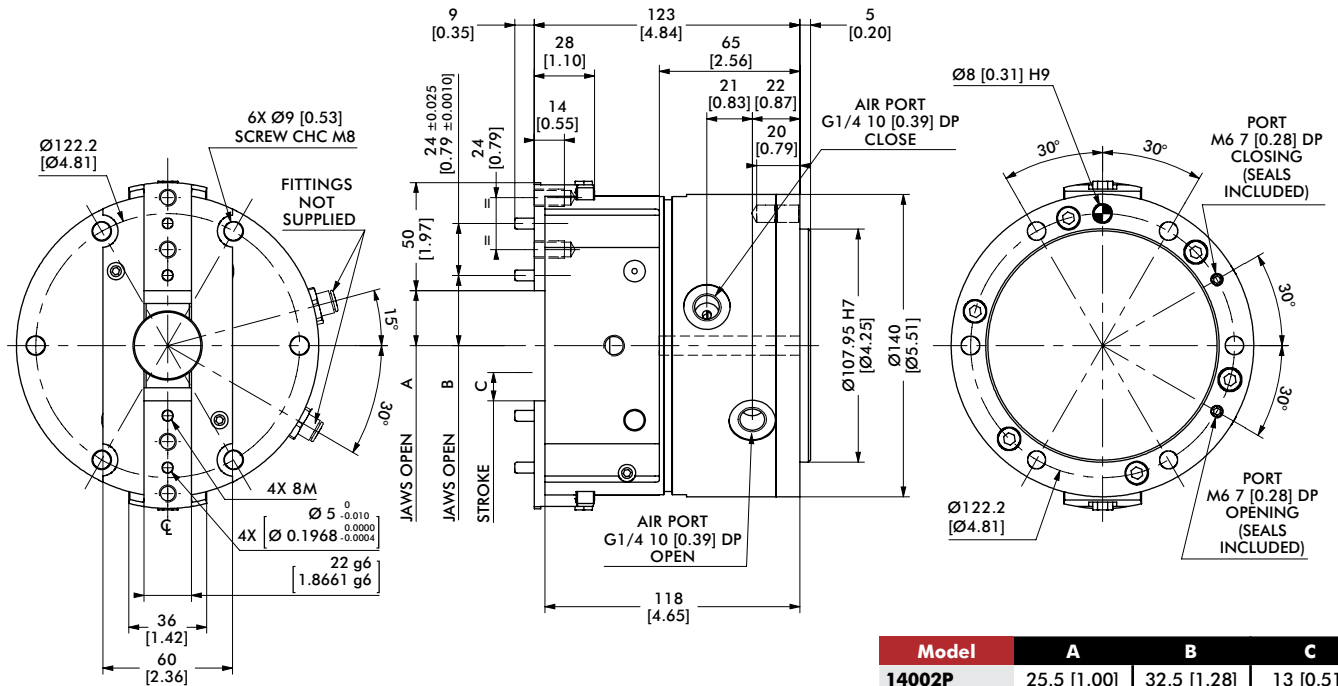

Model	A	B	C
14002P	25.5 [1.00]	32.5 [1.28]	13 [0.51]
14002P-C	32.5 [1.28]	39.5 [1.56]	20 [0.79]

Dimensions in mm [in]

Protective Boots	14002P
PVC Protective Boot, Brown or Black	KP-311
Fireproof KEVLAR Protective Boot, Red	KP-313

Seal Repair Kits	14002P
Buna-N Seal Repair Kit	SLKT-333
Viton® Seal Repair Kit	SLKT-333V
Hydraulic Seal Repair Kit	SLKT-334

Loading Information

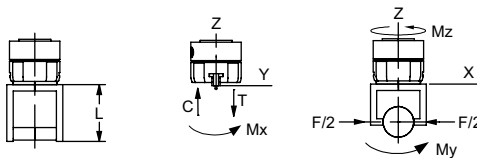
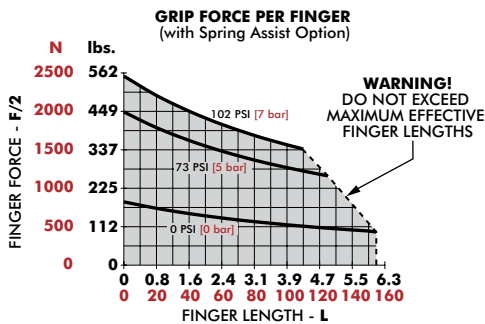

14002P	Static	Dynamic
Maximum Tensile T	1600 N [360 lbs]	550 N [124 lbs]
Maximum Compressive C	1820 N [409 lbs]	550 N [124 lbs]
Maximum Moment M_x	55 Nm [487 in-lbs]	18 Nm [159 in-lbs]
Maximum Moment M_y	90 Nm [797 in-lbs]	30 Nm [266 in-lbs]
Maximum Moment M_z	90 Nm [797 in-lbs]	30 Nm [266 in-lbs]

[†]Capacities are per set of jaws and are not simultaneous

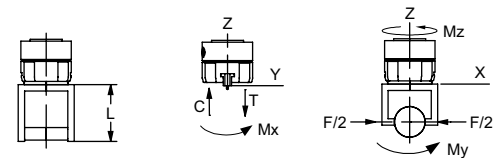
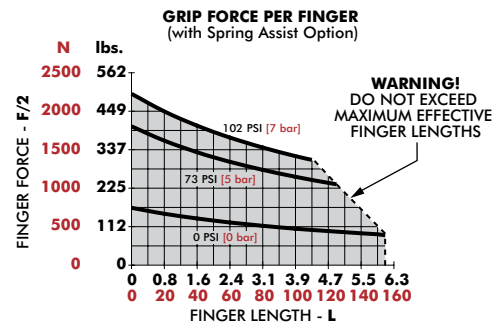

14002P-C	Static	Dynamic
Maximum Tensile T	1450 N [326 lbs]	400 N [90 lbs]
Maximum Compressive C	1450 N [326 lbs]	400 N [90 lbs]
Maximum Moment M_x	50 Nm [443 in-lbs]	15 Nm [133 in-lbs]
Maximum Moment M_y	75 Nm [664 in-lbs]	25 Nm [221 in-lbs]
Maximum Moment M_z	75 Nm [664 in-lbs]	25 Nm [221 in-lbs]

[†]Capacities are per set of jaws and are not simultaneous

16502P, 16502P-C

2-Jaw Precision Parallel Grippers | Dimensions and Technical Specifications

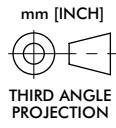
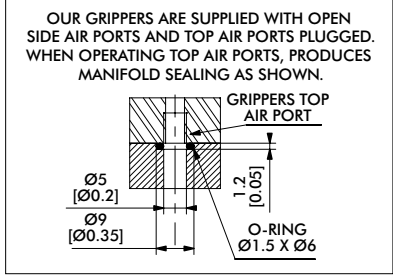
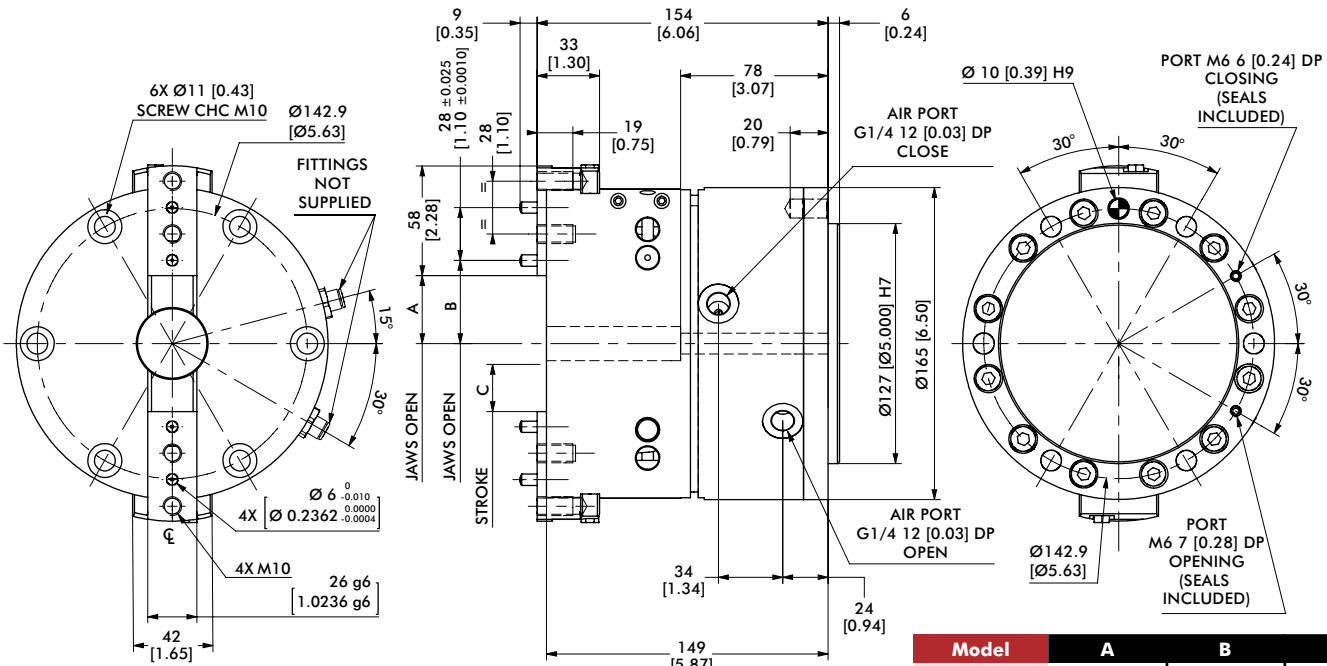

Model	A	B	C
16502P	31 [1.22]	39 [1.54]	15 [0.59]
16502P-C	36 [1.42]	44 [1.73]	25 [0.98]

Dimensions in mm [in]

Protective Boots	16502P
PVC Protective Boot, Brown or Black	KP-314
Fireproof KEVLAR Protective Boot, Red	KP-316
Seal Repair Kits	16502P
Buna-N Seal Repair Kit	SLKT-335
Viton® Seal Repair Kit	SLKT-335V
Hydraulic Seal Repair Kit	SLKT-336

Loading Information

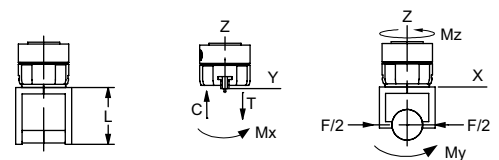
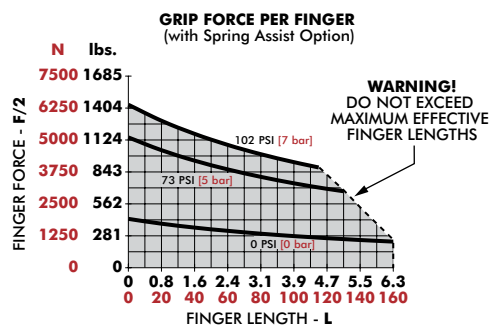

16502P	Static	Dynamic
Maximum Tensile T	1720 N [387 lbs]	650 N [146 lbs]
Maximum Compressive C	2160 N [485 lbs]	650 N [146 lbs]
Maximum Moment M_x	70 Nm [620 in-lbs]	17 Nm [150 in-lbs]
Maximum Moment M_y	100 Nm [885 in-lbs]	30 Nm [266 in-lbs]
Maximum Moment M_z	100 Nm [885 in-lbs]	30 Nm [266 in-lbs]

*Capacities are per set of jaws and are not simultaneous

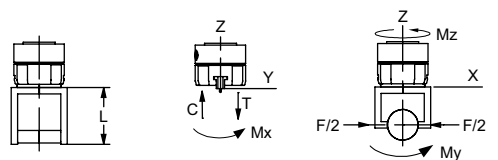
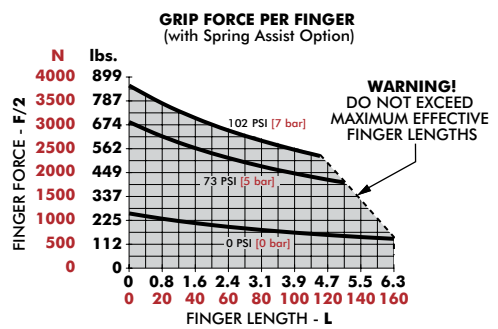

16502P-C	Static	Dynamic
Maximum Tensile T	1550 N [348 lbs]	580 N [130 lbs]
Maximum Compressive C	1950 N [438 lbs]	580 N [130 lbs]
Maximum Moment M_x	60 Nm [531 in-lbs]	20 Nm [177 in-lbs]
Maximum Moment M_y	80 Nm [708 in-lbs]	25 Nm [221 in-lbs]
Maximum Moment M_z	90 Nm [797 in-lbs]	25 Nm [221 in-lbs]

*Capacities are per set of jaws and are not simultaneous

2-Jaw Precision Parallel Grippers | Dimensions and Technical Specifications

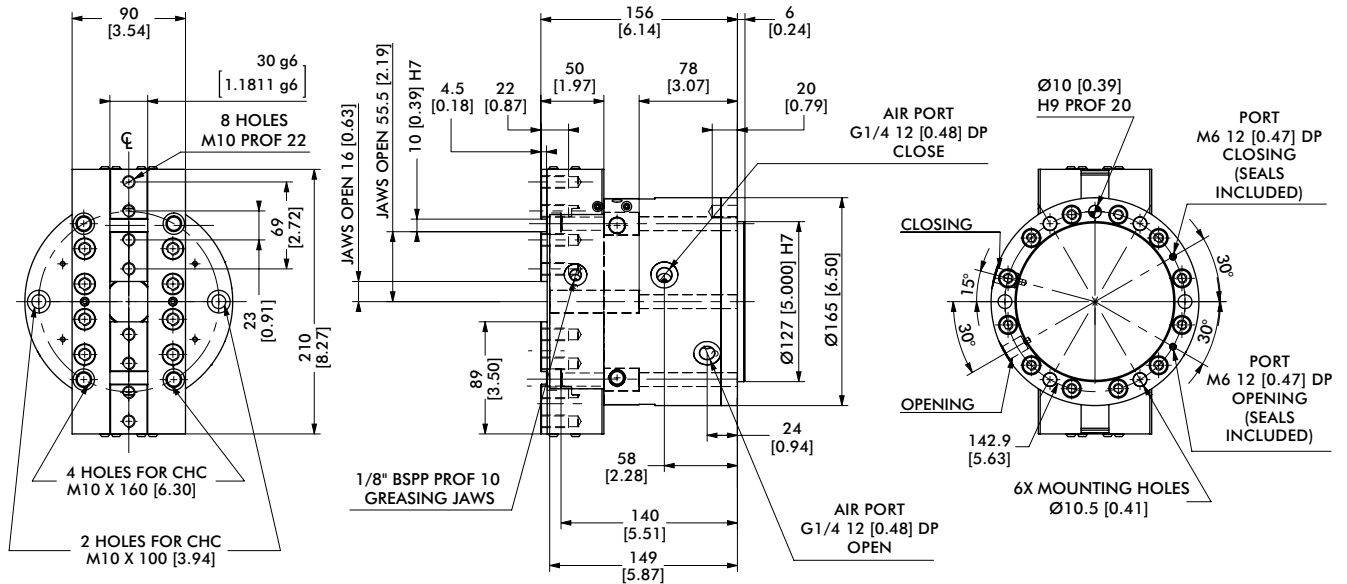

OUR GRIPPERS ARE SUPPLIED WITH OPEN SIDE AIR PORTS AND TOP AIR PORTS PLUGGED. WHEN OPERATING TOP AIR PORTS, PRODUCES MANIFOLD SEALING AS SHOWN.

GRIPPERS TOP AIR PORT
O-RING Ø1.5 X Ø6
1.2 [0.05]
Ø5 [Ø0.2]
Ø9 [Ø0.35]

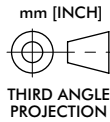

Protective Boots	16502PGR
Fireproof KEVLAR Protective Boot, Red	KENVE2-21384
Seal Repair Kits	16502PGR
Buna-N Seal Repair Kit	SLKT-335
Viton® Seal Repair Kit	SLKT-335V
Hydraulic Seal Repair Kit	SLKT-336

Loading Information

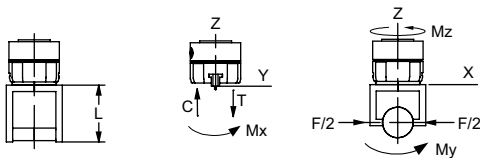
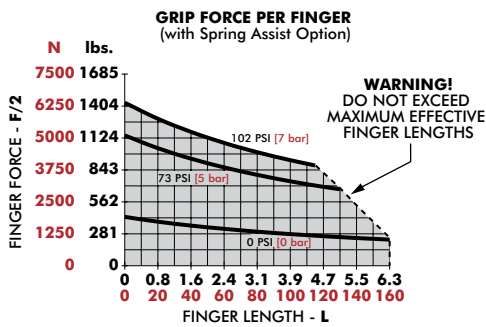

16502PGR	Static
Maximum Tensile T	5200 N [1169 lbs]
Maximum Compressive C	6400 N [1438 lbs]
Maximum Moment M_x	270 Nm [2390 in-lbs]
Maximum Moment M_y	350 Nm [3098 in-lbs]
Maximum Moment M_z	300 Nm [2655 in-lbs]

^cCapacities are per set of jaws and are not simultaneous

2P OPTIONS & ACCESSORIES

2-Jaw Parallel Grippers | Dimensions and Technical Specifications

SUPPLY: (P) Pneumatic (H) Hydraulic

As standard, the clamp is supplied with air to a pressure of 7 bar. On request (contact us) the gripper can be supplied with hydraulic fluid. The clamp is fitted with seals Viton Quad-Ring.

- Choice (H) allows a hydraulic power to a pressure of 20 bar max. In this case the overall dimensions do not change. For better security the gripper must be fixed on their support before being fired.

CAUTION: Hydraulic cycle times are longer.

The hydraulic power is incompatible with the option tandem (M).

Option (RE) or (RI): Spring Assist

The internal springs of the gripper ensures grip force is maintained by retaining the component during pressure loss, to increase the gripforce, or allows the usage of the gripper in single acting operation.

Option (RE) for external gripping. Option (RI) for internal gripping.

The (RE) is incompatible with the option (RI).

Option (T): Sensor Rod

Option (T) is a steel rod which comes out on the rear side of the gripper. The rod is fixed with the piston and has the same stroke movement. The open end of the rod allows for mounting a cam which allows to control the position of the jaws by using inductive sensors, micro switches, etc

WARNING: when screwing on cam rod, make sure the sensor rod does not rotate to prevent twisting of the springs of options (RE) or (RI).

Option (T) is incompatible with option (K).

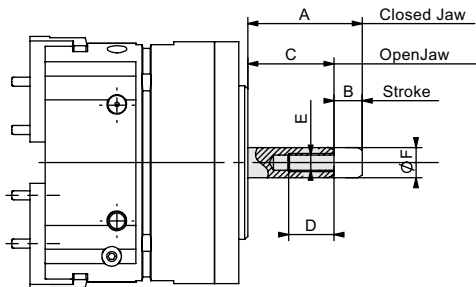

Model	A	B	C	D	E	F
6002P & 6002P-C	35	5	30	15	M6	10
8002P & 8002P-C	35	6.5	28.5	15	M6	10
11002P & 11002P-C	35	10	25	15	M6	15
14002P & 14002P-C	55	13	42	20	M8	15
16502P & 16502P-C	53	23	30	20	M8	15

Option (M): Tandem Cylinder

The (M) is a cylinder light-alloy that fits behind the bottom plate. This actuator's integral action allows to double the gripforce by using the same pressure. The combination of tandem option tandem (M) and Option (RE) or (RI) can double the clamping forces of the spring assist option. For cycle times of the tandem option, apply a factor of 3 to the actuation time.

The (M) is incompatible with the option (H).

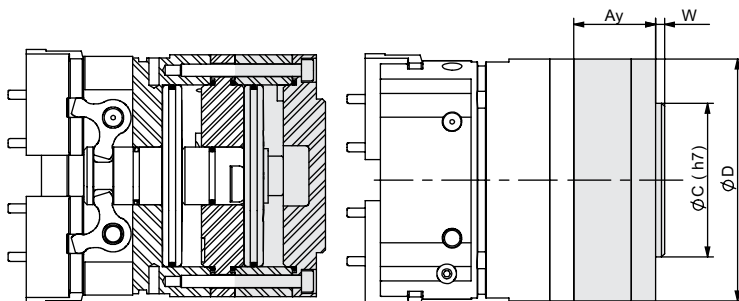

Model	Ay	ØC	ØD	W	Weight (kg)
6002P & 6002P-C	28.5	38.1	60	3	0.200
8002P & 8002P-C	27	50.8	80	3	0.300
11002P & 11002P-C	34	76.2	110	3	0.750
14002P & 14002P-C	49	107.95	140	5	2.100
16502P & 16502P-C	65	127	165	6	3.600

2P OPTIONS & ACCESSORIES

2-Jaw Parallel Grippers | Dimensions and Technical Specifications

Option (KT1), (KX1), (KT2), (KX2): Sensor Unit

The **(K)** is a lightweight alloy housing that fits on the back of the gripper. An integrated shaft follows the movement of the piston to provide information to the sensor attached to the side of the unit. It can control two positions of the grippers jaws. 2 types of inductive sensors (**KT, KX**) and 2 detection zones (**1, 2**) are possible to allow for the combination of 2 to 4 possible positions (**KT1, KX1, KT2, KX2**). For **KT, KX** sensor specifications.

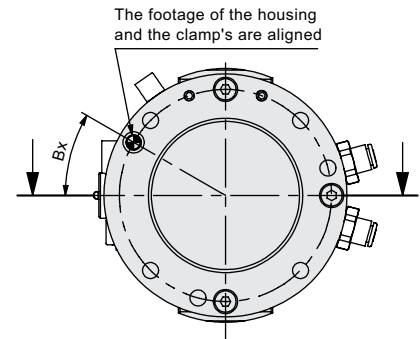
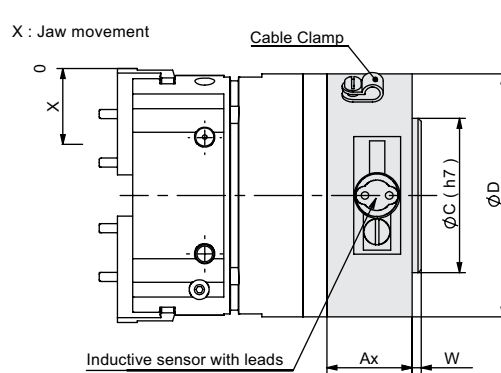
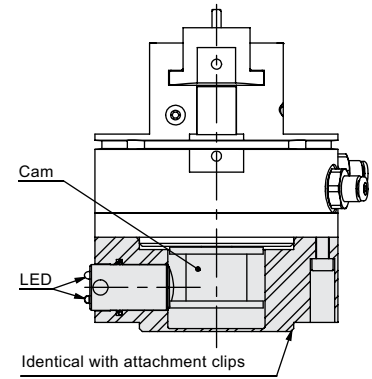

Model	Ax	Bx	ØC	ØD	W	Weight (kg)	No. of Sensing Positions (please specify when ordering)	Information area from the open grip position (green LED) X (mm)	Area information relative to the closed grip position (yellow LED) X (mm)
6002P	23	30°	38.1	60	3	0.180	1	0 or 1	4
							2	0 or 2	3
6002P-C	23	30°	38.1	60	3	0.180	1	0 or 1.6	7
							2	0 or 3.2	4.8
8002P	28	30°	50.8	80	3	0.400	1	0 or 1	5.5
							2	0 or 2	4.5
8002P-C	28	30°	50.8	80	3	0.400	1	0 or 1.5	8.5
							2	0 or 3.1	6.9
11002P	36	30°	76.2	110	3	0.900	1	0 or 1	9
							2	0 or 3	7
11002P-C	36	30°	76.2	110	3	0.900	1	0 or 1.5	13.5
							2	0 or 4.5	10.5
14002P	45.5	165°	107.95	140	5	1.670	1	0 or 2	11
							2	0 or 4	9
14002P-C	45.5	165°	107.95	140	5	1.670	1	0 or 3	17
							2	0 or 6.2	13.8
16002P	65.5	165°	127	165	6	2.670	1	0 or 2	13
							2	0 or 4	11
16002P-C	65.5	165°	127	165	6	2.670	1	0 or 3.3	21.7
							2	0 or 7	18

2P OPTIONS & ACCESSORIES

2-Jaw Parallel Grippers | Dimensions and Technical Specifications

Option (V): Viton® Seals

Gripper with Viton® seals allows for use in high temperature environments [-30 ° C or 150 ° C].

Accessory (E): Protective Boot

The accessory (E) is a protective boot that fits over the gripper. It protects the mechanism and thus improves the life of the gripper in hostile environments. The accessory (E) causes a different location of the fingers on the jaws as compared to the standard installation. Before attaching the boot, perform the following steps:

1. Mount gripper to machine.
2. Slip boot over gripper and secure in place.
3. Attached fingers to jaws using finger adapter.

Depending on the environment 2 types of envelopes are available:

- (E) Envelope of black or brown PVC for environmental grinding with emery presence.
- (E3) red envelope containing KEVLAR fireproof silicone environment for hot chips and weld spatter.

The accessory (E) is incompatible with the accessory (SD)

Model Code	Order #	Model	A	B	C	D	E	F	G	H	J	K	S	T	TX	V	Y
E	ER62P	6002P & 6002P-C	88	98	35	13.5	8	29	29	17.5	13	-	3	M4	9	13	6
E3	E3R62P																
E	ER82P	8002P & 8002P-C	89	110	34	13.5	10	33	30	22.3	16	-	3	M5	10	16	6
E3	E3R82P																
E	ER112P	11002P & 11002P-C	See Drawing														
E3	E3R112P																
E	KP-311	14002P & 14002P-C	143	185	50	18	12	55	34	19.5	24	18	5	M8	14	-	8
E3	KP-313																
E	KP-314	16002P & 16002P-C	172	220	70	16	14	67	37	24 19	28	23	6	M10	19	-	8
E3	KP-316																

6002P & 8002P

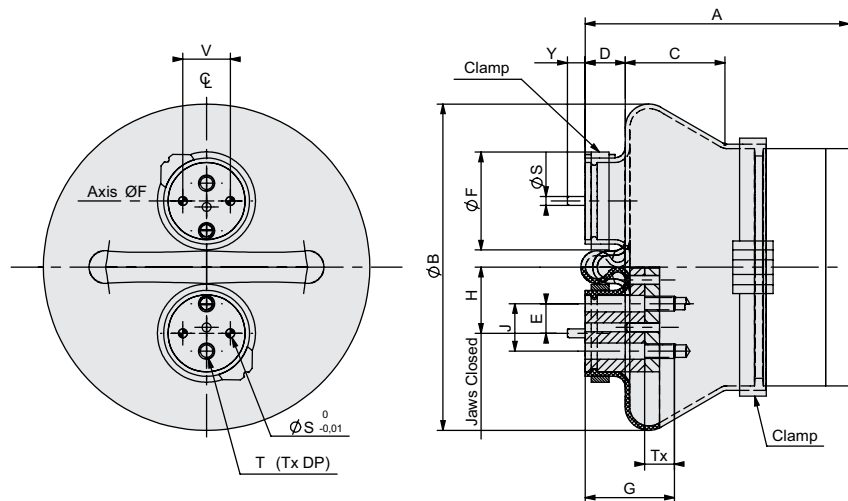

2P OPTIONS & ACCESSORIES

2-Jaw Parallel Grippers | Dimensions and Technical Specifications

11002P

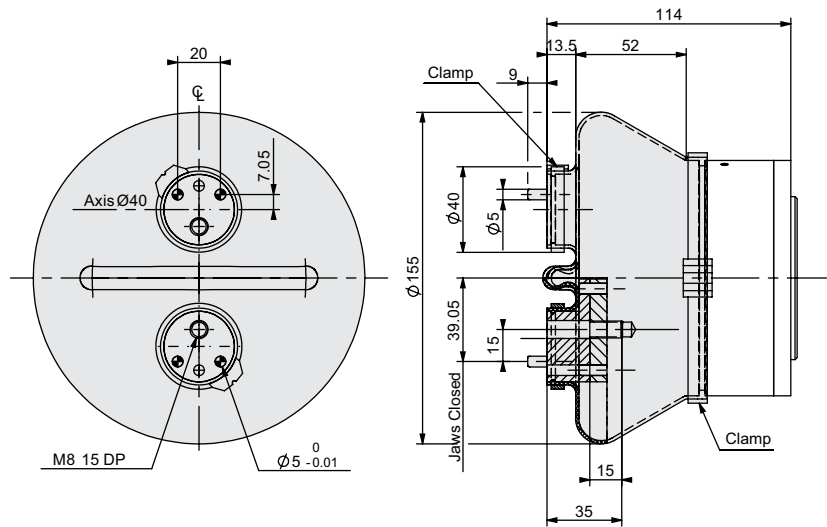

14002P & 16502P

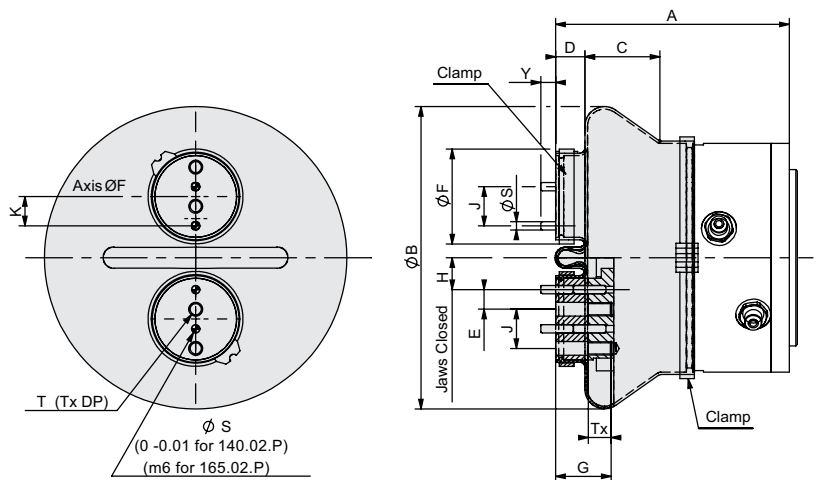

Accessory (SD): Inductive Sensor Mounting Kit

Allows for sensing of two positions: open and closed jaw. The accessory kit (SD) includes: 1 sensor bracket, 1 flag and screws. **Sensors are not provided.**

NOTES: To be usable, the cylindrical inductive sensors selected by the customer must have tapped their bodies to a minimum depth H (see table below).

Depending on their length, the cylindrical inductive sensors can extend below the clamp, requiring provision of suitable housing in the surrounding parts. It is possible to control more than 2 positions using a second attachment (SD).

Ability to adapt a second set of sensors on this jaw

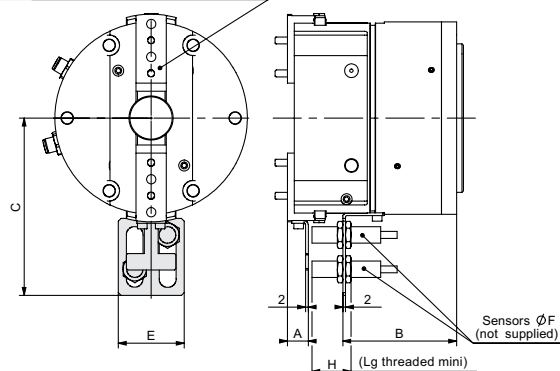

Order #	Model	A	B	C	E	F	H
SD60-80P	6002P & 6002P-C	20	35	67	32	8	35
SD60-80P	8002P & 8002P-C	19	34	77	32	8	35
SD110P	11002P & 11002P-C	19.5	45	97	32	8	35
OSMK-114	14002P & 14002P-C	15	83	129	48	12	28.5
OSMK-115	16502P & 16502P-C	29	96	147	48	12	33