

DLB SERIES - EXTERNAL AIR CYLINDER

External Air Cylinder Linear Base Slides | Features and Benefits | How To Order

Features:

- Bearing system for smooth operation
- Rugged design produces very reliable long life operation
- Replaceable air cylinder with adjustable cushions
- Non-powered Thrusters use customer supplied cylinders
- Urethane bumpers, hardened pads, oil wick
- Optional telescopic airlines transfers air to tooling
- DIRECTCONNECT™ mounting pattern
- Corrosion resistant shafting for corrosive environments
- Position sensing using inductive or magneto resistive sensors

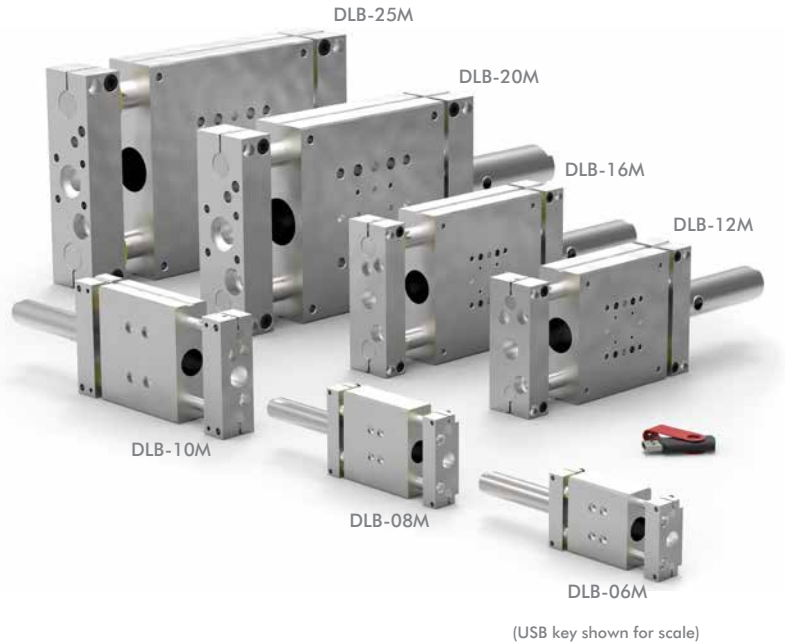

Applications:

- Machining and automation applications
- Harsh environment pick-and-place applications
- OEM machines
- Gantry systems

How To Order

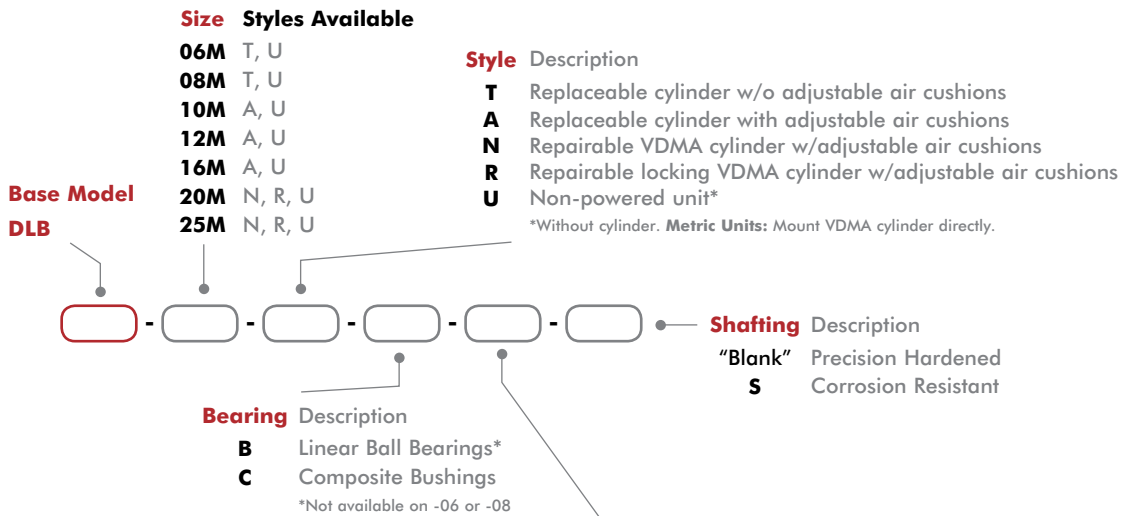

Size	Style	Stroke* Metric (mm)
DLB-06M	T, U	10, 25, 40, 50, 75, 100, 125, 160
DLB-08M	T, U	10, 25, 40, 50, 75, 100, 125, 160, 175, 200
DLB-10M	A, U	25, 50, 80, 100, 125, 160, 200, 250, 300
DLB-12M	A, U	25, 50, 80, 100, 125, 160, 200, 250, 300, 320, 360, 400
DLB-16M	A, U	25, 50, 80, 100, 125, 160, 200, 250, 300, 320, 360, 400, 500
DLB-20M	N, R, U	25, 50, 80, 100, 125, 160, 200, 250, 300, 320, 360, 400, 500
DLB-25M	N, R, U	25, 50, 80, 100, 125, 160, 200, 250, 300, 320, 360, 400, 500

*Custom strokes available. Consult factory.

DLB SERIES - EXTERNAL AIR CYLINDER

External Air Cylinder Linear Base Slides | Accessories

Shock/Stop Accessories	Model Sizes	Style	Part Number	Qty/Unit
Shock Absorber	06, 08	All	SHOK-030	1-2
	10		SHOK-028	
	12, 16,		SHOK-010	
	20, 25		SHOK-029	
Adjustable Hard Stop	06, 08		DLT-0623	
	10, 12, 16, 20, 25	DLT-1023		

Sensor Accessories	Model Sizes	Style	Part Number	Qty/Unit
PNP Inductive Sensor with Quick Disconnect*	All Models	All	OISP-011	1-2
NPN Inductive Sensor with Quick Disconnect*			OISN-011	
PNP Magneto Resistive Sensor w/Qk Disconnect*	06, 08, 10, 12, 16	T, A	OHSP-005	
NPN Magneto Resistive Sensor w/Quick Disconnect*			OHSN-005	
PNP Magneto Resistive Sensor w/Qk Disconnect*	20, 25	N, R	OHSP-020	
Quick Disconnect 2 Meter Cable Length*	All Models	All	CABL-010	
Quick Disconnect 5 Meter Cable Length*			CABL-013	
Cable Extension Cord 1M Length*	All Models	All	CABL-015	
Cable Extension Cord 2M Length*			CABL-016	

Pneumatic Accessories	Model Sizes	Style	Part Number	Qty/Unit
G1/8 Telescopic Airlines (up to 160mm)	10, 12, 16	All	OTAL-045	1-4
G1/8 Telescopic Airlines (up to 300mm)	10, 12, 16		OTAL-046	
G1/8 Telescopic Airlines (up to 450mm)	10, 12, 16, 20, 25		OTAL-047	
G1/8 Telescopic Airlines (up to 600mm)	20M, 25M		OTAL-048	
G1/8 Adjustable Flow Control	10, 12, 16, 20, 25		VLVF-005	1-2
G1/8 Male to 1/8 NPT Adapter	20, 25	PLFT-025		

* Sensor and cable sold separately.

See page GR-LIN-35 for Accessory Mounting Technical Data.

DLB SERIES - EXTERNAL AIR CYLINDER

External Air Cylinder Linear Base Slides | Technical Specifications

Specifications	Units	06-T, U	08-T, U	10-A, U	12-A, U
Max. Air Pressure	bar [psi]	7 [100]			
Thrust Force @ 5.5 bar [80psi]	N [lbs]	89 [20]		145 [31]	289 [65]
Weight (basic unit)	kg [lb]	0.15 [0.34]	0.31 [0.69]	0.90 [1.98]	1.66 [3.73]
Additional Weight per Stroke	g/mm [lbs/in]	0.88 [0.05]	1.23 [0.07]	1.4 [0.09]	2.9 [0.16]
Cylinder Bore Ø	mm [in]	16 [0.563]		20 [0.75]	25 [1.00]
Shaft Ø	mm [in]	6 [0.236]	8 [0.315]	9.5 [0.375]	12 [0.472]
Maximum Moment Load	N-m [in-lbs]	1.7 [15]	3.4 [30]	8.4 [75]	16.9 [150]

Specifications	Units	16-A, U	20-A, N, R, U	25-A, N, R, U
Max. Air Pressure	bar [psi]	7 [100]		
Thrust Force @ 5.5 bar [80psi]	N [lbs]	289 [65]	443 [100]	443 [100]
Weight (basic unit)	kg [lb]	2.3 [5.03]	5.9 [12.9]	8.3 [18.0]
Additional Weight per Stroke	g/mm [lbs/in]	4.2 [0.23]	9.5 [0.53]	12.1 [0.68]
Cylinder Bore Ø	mm [in]	25 [1.00]	32 [1.25]	32 [1.25]
Shaft Ø	mm [in]	16 [0.630]	20 [0.787]	25 [0.984]
Maximum Moment Load	N-m [in-lbs]	33.9 [300]	67.8 [600]	135 [1200]
Min. Air Pressure to Release Cylinder Lock -R	bar [psi]		4 [60]	4 [60]
Holding Force of Locking Mechanism -R	N [lbs]		550 [123]	550 [123]

External Air Cylinder Linear Base Slides | Dimensions and Technical Specifications

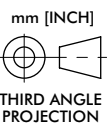
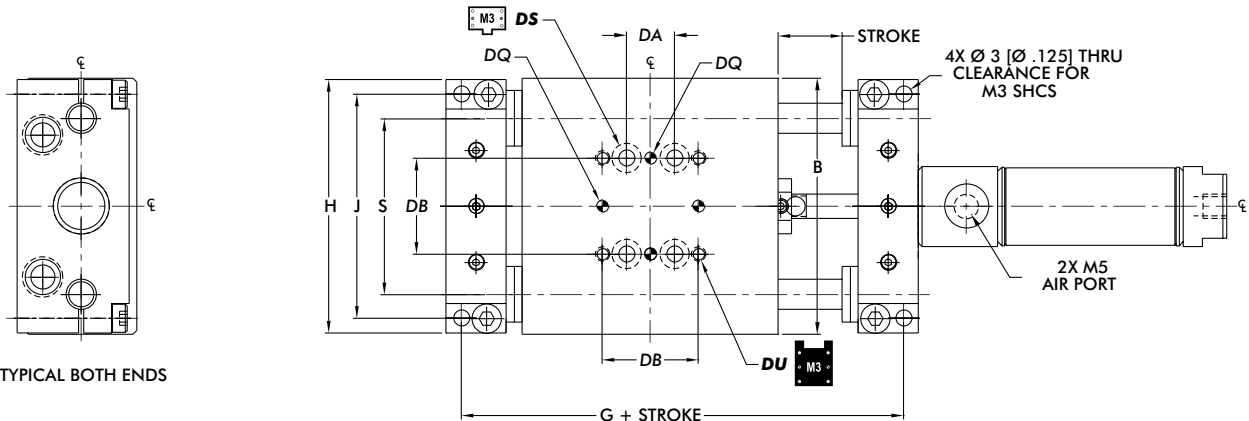

DIRECTCONNECT™ Mounting Pattern Dimensions (all sizes)				
DA	DB	DQ	DS	DU
9.5 [0.375]	19.1 [0.750]	3H7 X 2 DP	CLR & C'BORE FOR M3	M3 x 6 DP

Model	Bore Ø	Body Size	Shaft Ø	Basic Unit Dimensions									
				A	B	C	D	E	G	H	J	K	L
DLB-06M	16 [0.563]	50.8 [2.00]	6.0 [0.236]	48.4 [1.91]	81.0 [3.19]	75.1 [2.956]	50.3 [1.980]	44.4 [1.750]	22.2 [0.875]	23.7 [0.936]	11.9 [0.470]	11.13 [0.438]	34.93 [1.375]
DLB-08M		63.5 [2.50]	8.0 [0.315]		93.7 [3.69]	87.8 [3.456]	62.7 [2.470]	57.1 [2.250]					

Dimensions in mm [in]

Loading Information

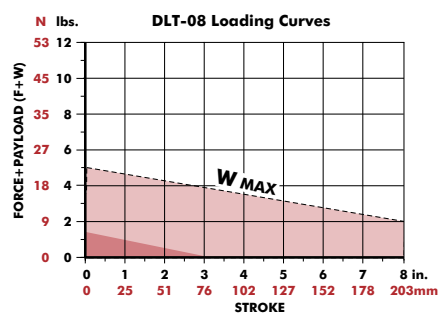
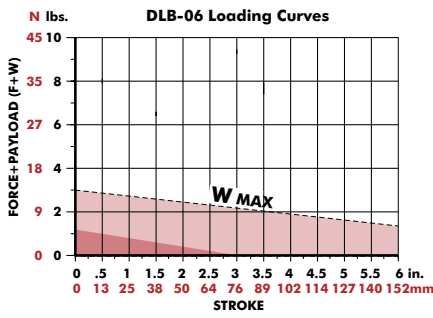

Shock Absorbers and Flow Controls are recommended for all applications

F=Externally applied force
W=Weight of payload
F+W=Total force

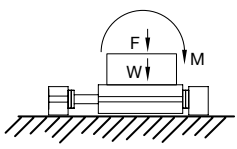

(W) in this range use **Single Shock** in both directions (W) in this range use **Bumpers or Cushioned Cylinder**

Shaded shock absorption ranges of horizontal payload (W) @ 80psi, flow controls fully open. For vertical applications do not exceed 1/2 of the recommended payload due to the additional acceleration effect of gravity.

DLB-10/12/16M-A, U

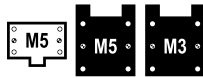

External Air Cylinder Linear Base Slides | Dimensions and Technical Specifications

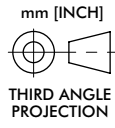
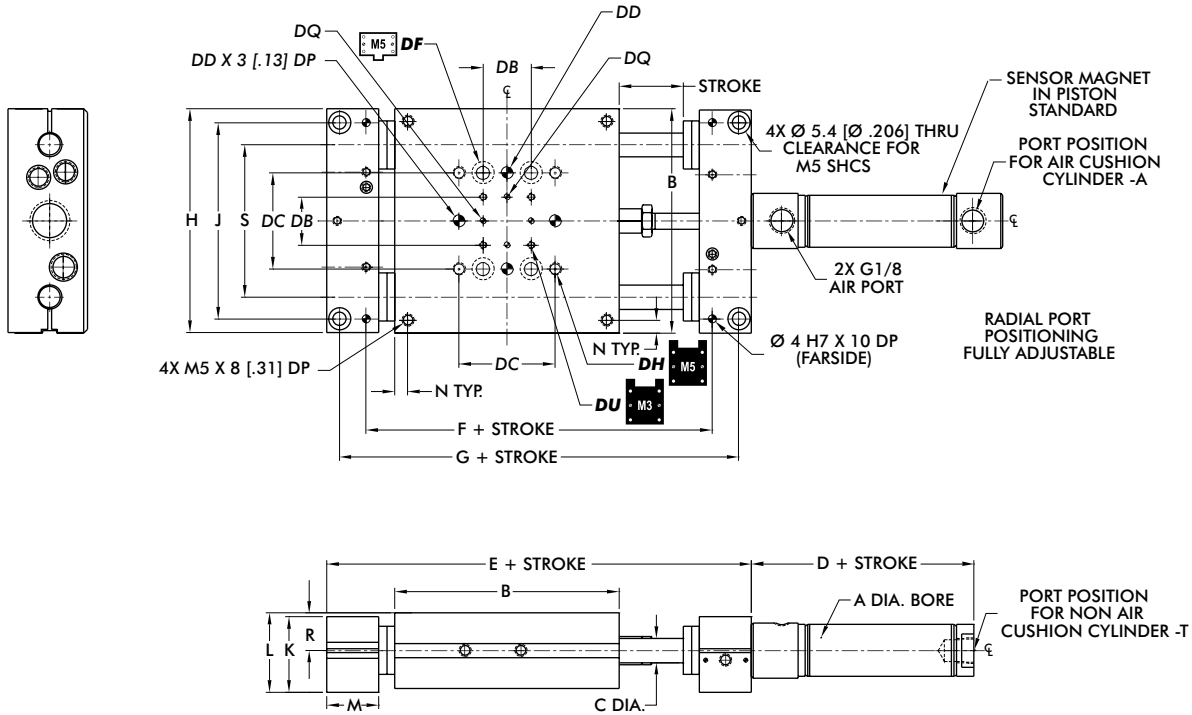

DIRECTCONNECT™ Mounting Pattern Dimensions (all sizes)						
DB	DC	DD	DF	DH	DQ	DU
19.1 [0.750]	38.1 [1.500]	5mm H7 X 6 DP	CLEARANCE FOR M5	M5 X 8.5DP	3H7 X 2 DP	M3 X 6 DP

Model	Bore Ø	Body Size	Shaft Ø	Basic Unit Dimensions											
				A	B	C	D	E	F	G	H	J	K	L	M
DLB-10M	20 [0.75]	88.9 [3.50]	9.5 [0.375]	88.0 [2.91]	149.4 [5.63]	118.05 [4.3975]	139.1 [5.228]	88.5 [3.485]	77.7 [3.060]	29.9 [1.178]	31.6 [1.245]		N/A	15.09 [0.594]	60.33 [2.375]
DLB-12M	25 [1.00]	101.6 [4.00]	12 [0.472]	91.5 [2.88]	162.1 [6.13]	130.75 [4.8975]	151.8 [5.728]	101.2 [3.985]	88.9 [3.500]	41.0 [1.615]	42.1 [1.657]	20.7 [0.813]	9.5 [0.375]	20.65 [0.813]	69.85 [2.750]
DLB-16M		120.7 [4.75]	16 [0.630]		181.1 [6.88]	149.80 [5.6475]	170.9 [6.478]	120.3 [4.735]	107.9 [4.250]						82.55 [3.250]

Dimensions in mm [in]

Loading Information

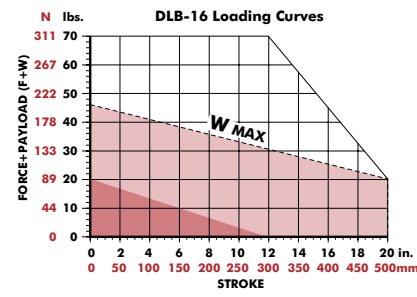
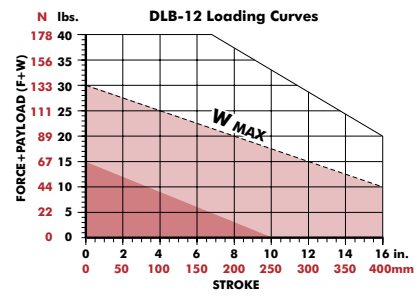
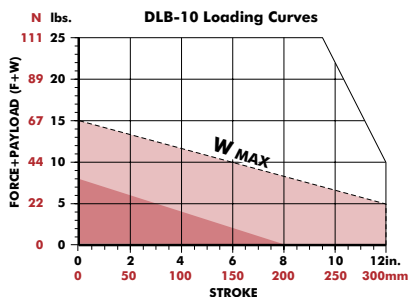

F=Externally applied force
W=Weight of payload
F+W=Total force

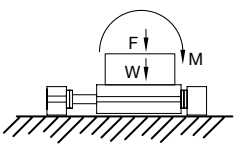

Shock Absorbers and Flow Controls are recommended for all applications

(W) in this range use Single Shock in both directions (W) in this range use Bumpers or Cushioned Cylinder

Shaded shock absorption ranges of horizontal payload (W) @ 80psi, flow controls fully open. For vertical applications do not exceed 1/2 of the recommended payload due to the additional acceleration effect of gravity.

External Air Cylinder Linear Base Slides | Dimensions and Technical Specifications

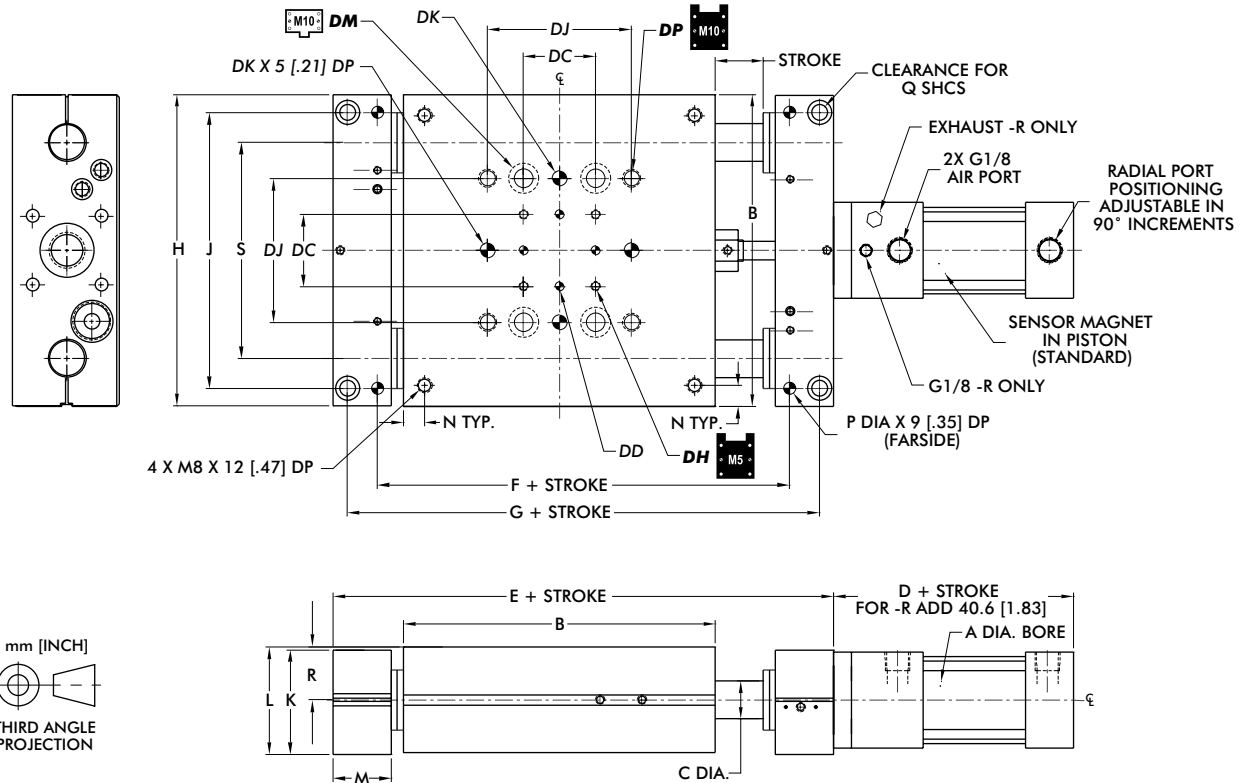

DIRECTCONNECT™ Mounting Pattern Dimensions (all sizes)

DC	DD	DH	DJ	DK	DM	DP
38.1 [1.500]	5 mm H7 X 6 DP	M5 X 8.5 DP	76.2 [3.000]	8 mm H7 X 9.4 DP	CLR & C'BORE FOR M10	M10 X 12 DP

Model	Bore Ø Body Ø Shaft Ø			Basic Unit Dimensions													
	A	B	C	D	E	F	G	H	J	K	L	M	N	P	Q	R	S
DLB-20M	32 [1.25]	165.1 [6.50]	20 [0.787]	98.0 [3.63]	239.3 [9.42]	192.66 [7.5850]	224.4 [8.836]	164.6 [6.480]	146.05 [5.7500]	55.4 [2.180]	56.8 [2.236]	30.7 [1.210]	11.1 [0.438]	6.00 [0.2505]	M8	27.94 [1.100]	114.30 [4.500]
DLB-25M		190.5 [7.50]	25 [0.984]		275.3 [10.84]	221.79 [8.7320]	256.7 [10.108]	190.0 [7.480]	171.45 [6.7500]			36.1 [1.420]		8.00 [0.3130]	M10		113.35 [5.250]

Dimensions in mm [in]

Loading Information

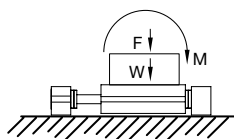
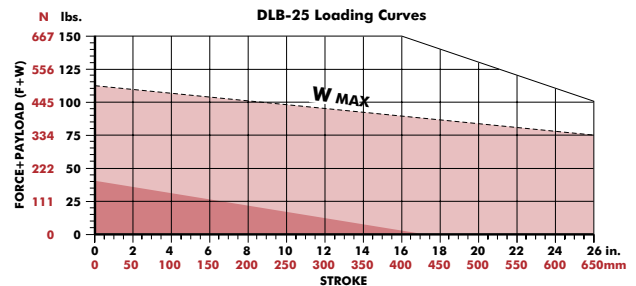
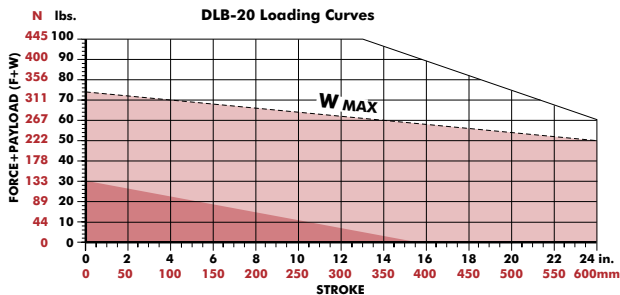

F=Externally applied force
W=Weight of payload
F+W=Total force

Shock Absorbers and Flow Controls are recommended for all applications

(W) in this range use **Single Shock** in both directions

(W) in this range use **Bumpers or Cushioned Cylinder**

Shaded shock absorption ranges of horizontal payload (W) @ 80psi, flow controls fully open. For vertical applications do not exceed 1/2 of the recommended payload due to the additional acceleration effect of gravity.