



ELECTRIC PARALLEL GRIPPERS

Electric Parallel Grippers | Product Overview



Model		Stroke mm [in]	Grip Force N [lbs]	Operating Environment	Special Features	Page GR-CRP-#
DPE 400		10-20 [0.39-0.78]	445-1334 [100-300]	IP 50 Clean Room Class 100, ISO 5, General Industrial	Adjustable Force, Discrete on/off open and close control. Onboard controls. DIRECTCONNECT	5
DPE 200		25 [0.98]	111 [25]	IP54 Clean Room Class 1000, ISO 6 General Industrial	Discrete on/off open and close control. Sealed design. Multiple sensor positions. Onboard controls. DIRECTCONNECT	7
RPE		4 [0.16]	5 [1.1]	IP54 Clean Room Class 10, ISO 4 using Scavenge Port, General Industrial	Discrete on/off 50ms pulse open and close control. Small parts handling. High speed.	9

ELECTRIC PARALLEL GRIPPERS

Electric Parallel Grippers | DIRECTCONNECT™ Modular Connectivity Chart

Modular DIRECTCONNECT Mounting Style Examples:

Products can be mounted in multiple positions. Refer to datasheet for complete info.

Slide to Gripper

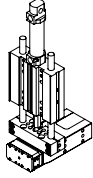

DLT Thruster Slide to
DPE-200 Electric Gripper

Slide to Gripper

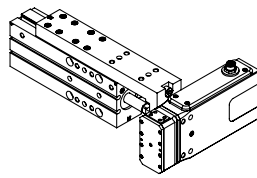

DLM Thruster Slide to
DPE-200 Electric Gripper

Rotary to Gripper

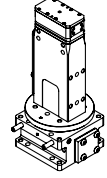

DRF Rotary Actuator to
DPE-200 Electric Gripper

Slide to Gripper

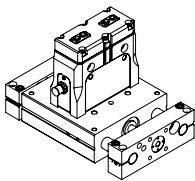

DLB Base Slide to
DPE-400 Electric Gripper

Slide to Slide

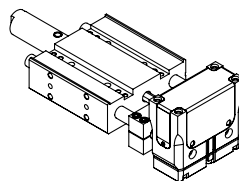

DLT Thruster Slide to
DPE-400 Electric Gripper

Slide to Gripper

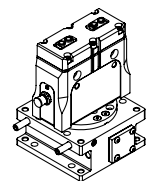

DRF Rotary Actuator to
DPE-400 Electric Gripper

DIRECTCONNECT™ Mounting Compatibility Chart

DESTACO's DIRECTCONNECT™ technology, allows all components of the system—grippers, rotaries and slides—to be mounted together directly. Look for matching icons on product datasheets for mounting compatibility.

Note: The numbers in the cell represent the metric screw size and basic mounting pattern.

S=Square, R=Rectangle. ie; 5S = M5 Screw with square mounting pattern.

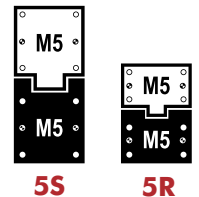

Catalog Models		2 Jaw Electric Parallel Grippers	
		DPE-200	DPE-400
Base Slides	DLB-06,08		
	DLB-10,12,16	5R	
	DLB-20,25		10R
Thruster Slides	DLT-06,08		
	DLT-10,12,16	5R	
	DLT-20,25	5R	10R
	DLM-07		
	DLM-9,12	5R	
Rotary Actuators	DRF-075,094	5R	
	DRF-106	5R	
	DRF-131	5R	10R

E-GRIPPER SERIES

Electric Parallel Grippers | Features and Benefits

Plug-and-Play e-Grippers

Quick Installation

Unit installs quickly using one cable for both power and operation. DIRECTCONNECT™ feature on DPE units allows mounting to rotaries and slides without adapter plates.

Light Switch Operation

No tuning or programming required. Grippers use discrete PLC outputs to control open and close operation. Grippers are powered by 24VDC.

Zero Maintenance

Zero maintenance required for standard environments. Units are internally lubricated and sealed. No air lines, valves, tubing, filters or compressor to interfere with high reliable operations.

100% Duty Cycle Operation for Durability

DPE Series supports continuous open/close command signal operation. Tight mechanical tolerances minimize wear leading to high life cycle operations.



DESTACO vs. Others

Features	DESTACO Light Switch Operation	Competing Units
Direct Mechanical Drive ¹	<input checked="" type="checkbox"/>	
Integrated Motor Controls ²	<input checked="" type="checkbox"/>	
Zero Maintenance ³	<input checked="" type="checkbox"/>	
DIRECTCONNECT™ ⁴	<input checked="" type="checkbox"/>	
Programming Software ⁵		<input checked="" type="checkbox"/>
Clean Room Certified	<input checked="" type="checkbox"/>	<input checked="" type="checkbox"/>
Zero Backlash/Side Play	<input checked="" type="checkbox"/>	

- DESTACO uses a direct mechanical linkage to drive the jaws and eliminate finger play, as opposed to a belt drive design.
- Integrated electronics decreases cabling and space requirements, while increasing overall system integrity.
- Competing units recommend lubrication maintenance intervals.
- DIRECTCONNECT™ allows units to be mounted to rotaries or slides without adapter plates.
- Light Switch operation products require no software.

E-GRIPPER SERIES

Electric Parallel Grippers | Compare the eGripper Series

Features	DPE-400	DPE-200	RPE-100
Grip Force Range	445-1334N [100-300 lbf]	111N [25 lbf]	5N [1.1 lbf]
Stroke Range	10mm [0.39 in] or 20mm [0.78 in]	25mm [0.98 in]	4mm [0.16 in]
Actuation (open/close)	800 ms	250 ms	100 ms
Accuracy	±0.05mm [0.002 in]	±0.05mm [0.002 in]	±0.05mm [0.002 in]
Jaw Drive Mechanism	Lead Screw/Wedge	Rack-and-Pinion	Solenoid Plunger
Adjustable Grip Force	<input checked="" type="checkbox"/>		
100% Duty Cycle	<input checked="" type="checkbox"/>	<input checked="" type="checkbox"/>	
DIRECTCONNECT™ Feature	<input checked="" type="checkbox"/>	<input checked="" type="checkbox"/>	
FailSafe Operation			<input checked="" type="checkbox"/>
Internal Sensing	<input checked="" type="checkbox"/>		
IP Rating	IP50	IP54	IP54

Clean Room Rated:

DESTACO's electric products are ideal for food, medical and clean room applications. Electric products are internally lubricated and sealed, per the chart below:

Clean Room Rating	DPE-400	DPE-200	RPE-100
	100	1000	100
Lubricant	Magnalube	Krytox	Krytox

Contact DESTACO for a full range of clean room certified products at solutions@destaco.com

DPE-400 HEAVY-DUTY

Electric Parallel Grippers | Features and Benefits | Technical Specifications

Features:

- Two stroke ranges from 0 to 10mm and 0 to 20mm
- Grip Force adjust-ability from 100% to 50% controlled from the 0 to 5VDC analog input
- Fully integrated electronics, no programming or software Operates from PLC discrete open/close commands
- Reverse polarity protection to protect from application mis-wiring
- DIRECTCONNECT™ mounting to rotaries and slides without requiring adapter plates
- Open and close sensing via built-in motor feedback signal
- Clean room 100 rated

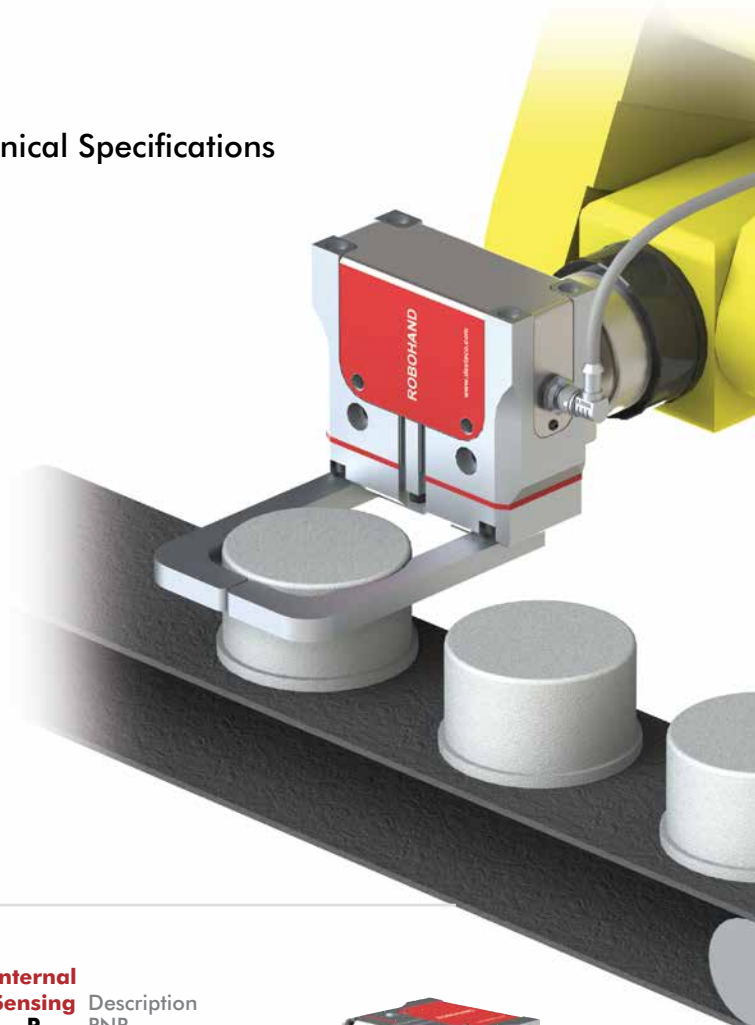

How To Order

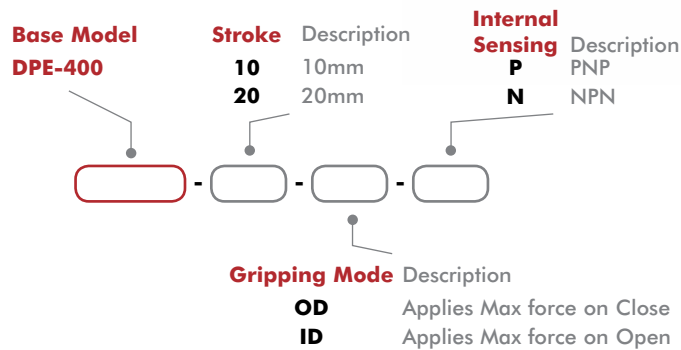

OD (Outside Diameter)



ID (Inside Diameter)

Accessories

Power and Sensor Accessories	Part Number
PNP Magneto-Resistive Position Sensor	OHSP-017
NPN Magneto-Resistive Position Sensor	OHSN-017
Quick Disconnect Sensor Cable, 5m long	CABL-013
8-wire Power and Signal Cable, 5m long with Straight M12 Connector	CABL-052
8-wire Power and Signal Cable, 5m long with 90° M12 Connector	CABL-053

*Sensor and cable sold separately.

Electrical Interface: Pin Out

(Looking into the head of the connector on gripper)

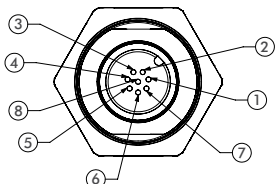

Voltage shown is applied to the FORCE pin, which accepts a 0-5V analog signal.

Pin #	Color	Signal	Description	Current
1	White	Force	0-5 VDC (Analog)	5mA
2	Brown	+24V	Motor Power	2A (max), 0.4 A (avg)
3	Green	Open	24 VDC Active (Inputs)	10mA
4	Yellow	Open Sense	NPN/PNP (Outputs)	300mA (max)
5	Gray	Close	24 VDC Active (Inputs)	10mA
6	Pink	Close Sense	NPN/PNP (Outputs)	300mA (max)
7	Blue	Ground	Motor Ground	2A (max),
8	Red	I/O Power	24 VDC (PNP Outputs Only)	300mA (max)

Electric Parallel Grippers | Dimensions and Technical Specifications

Specifications	Units	DPE-400
Total Rated Grip Force:		
DPE-400-10	N [lbf]	667-1334 [150-300]
DPE-400-20	N [lbf]	445-890 [100-200]
Total Stroke:		
DPE-400-10	mm [in]	10 [0.39]
DPE-400-20	mm [in]	20 [0.78]
Repeatability	mm [in]	±0.025 [0.001]
Accuracy	mm [in]	±0.05 [0.002]
Actuation Time	ms	800
Temperature Range	°C [°F]	0~55° [32°~131°]
Power Requirements @ 100% Duty Cycle	watts	10
Voltage	VDC	24
DC Current (Peak)	amps	2 (max)
DC Current: (Continuous)	amps	0.4
Ingress Protection Class (IP)		IP50
Clean Room		100 (MagnaLube)
Weight	kg [lbs]	2.52 [5.56]
Maximum Finger Length	mm [in]	125 [4.92]
Durability	cycles	3 Million

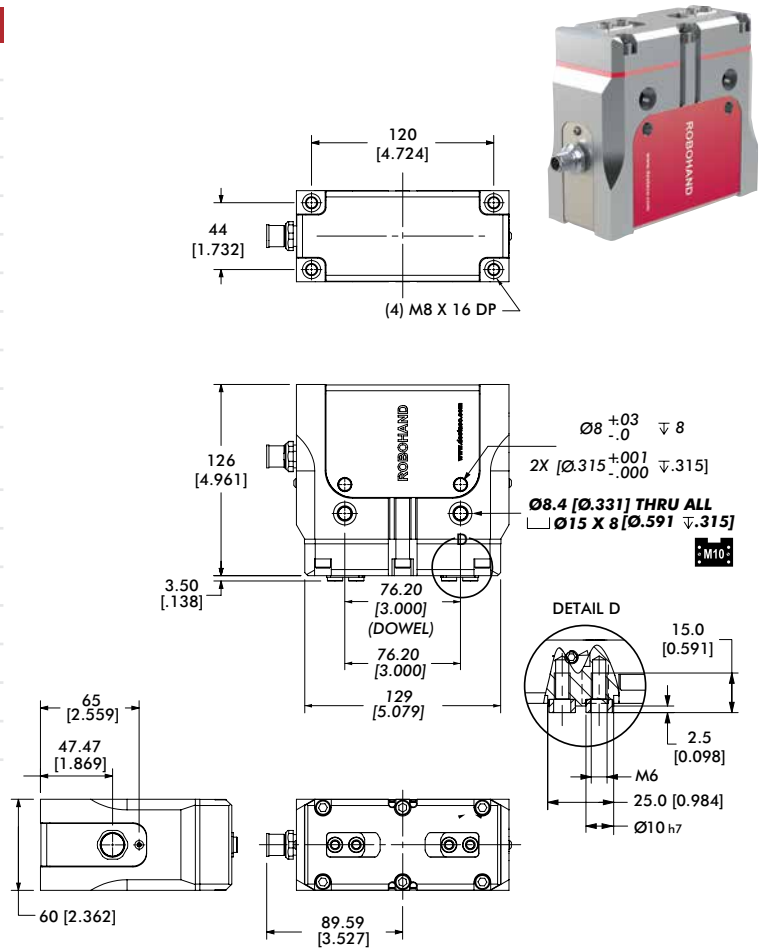
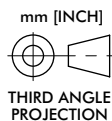

NOTE: REVERSE POLARITY PROTECTED

Loading Information

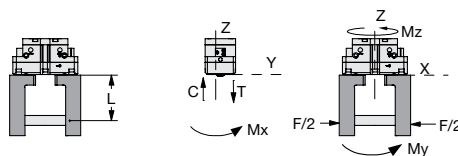
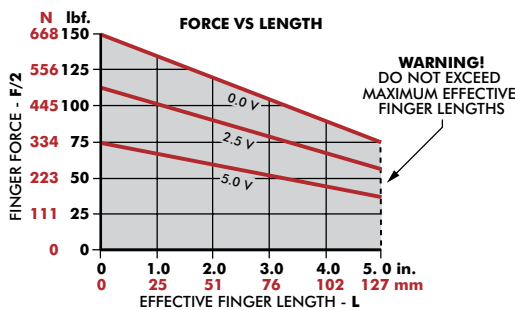

DPE-400-10	Static	Dynamic
Maximum Tensile T	1564 N [352 lbs]	259 N [58 lbs]
Maximum Compressive C	2070 N [465 lbs]	259 N [58 lbs]
Maximum Moment M_x	76 Nm [673 in-lbs]	10 Nm [89 in-lbs]
Maximum Moment M_y	106 Nm [938 in-lbs]	14 Nm [124 in-lbs]
Maximum Moment M_z	70 Nm [620 in-lbs]	14 Nm [124 in-lbs]

¹Capacities are per set of jaws and are not simultaneous

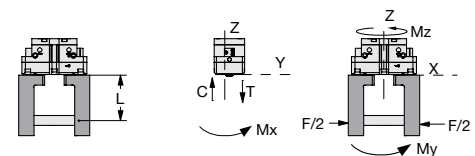
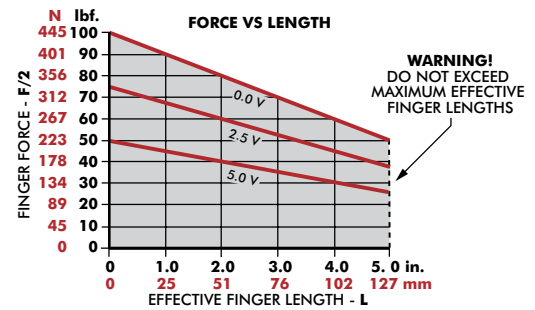

DPE-400-20	Static	Dynamic
Maximum Tensile T	1394 N [313 lbs]	168 N [38 lbs]
Maximum Compressive C	1845 N [415 lbs]	168 N [38 lbs]
Maximum Moment M_x	68 Nm [602 in-lbs]	6 Nm [53 in-lbs]
Maximum Moment M_y	84 Nm [743 in-lbs]	8 Nm [71 in-lbs]
Maximum Moment M_z	56 Nm [496 in-lbs]	8 Nm [71 in-lbs]

¹Capacities are per set of jaws and are not simultaneous

DPE-200 MEDIUM-DUTY

Electric Parallel Grippers | Features and Benefits | How To Order

Features:

- Ideal for semiconductor and life sciences laboratory applications
- Fast parts handling with grip speeds capable of 120 parts per minute with a 25mm stroke and 250ms actuation time
- High reliability up to four times longer than pneumatic equivalents
- Maintenance free internally lubricated and sealed
- Precision rack-and-pinion drive helps to maintain grip accuracy of +/- 0.05mm (0.002in)
- Fully integrated electronics, no programming or software. Operates from PLC discrete open/close commands
- Reverse polarity protection to protect from application mis-wiring
- DIRECTCONNECT™ mounting to rotaries and slides without requiring adapter plates
- Clean room 1000 rated

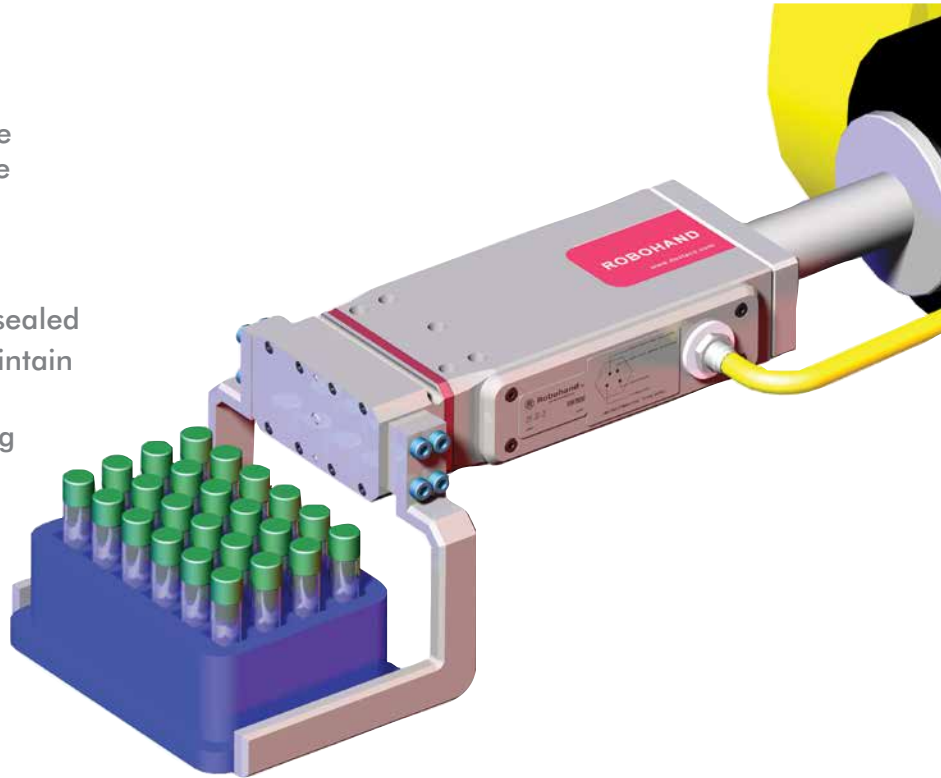

How To Order



Accessories

Power and Sensor Accessories	Part Number
PNP Magneto-Resistive Position Sensor	OHSP-017
NPN Magneto-Resistive Position Sensor	OHSN-017
Quick Disconnect Sensor Cable, 5m Long	CABL-013
4-wire Power and Signal Cable, 5m Long	CABL-046

*Sensor and cable sold separately.

Electrical Interface: Pin Out

(Looking into the head of the connector on gripper)

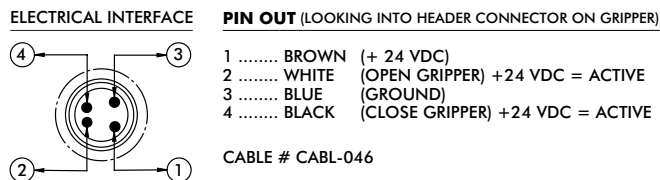

Electric Parallel Grippers | Dimensions and Technical Specifications

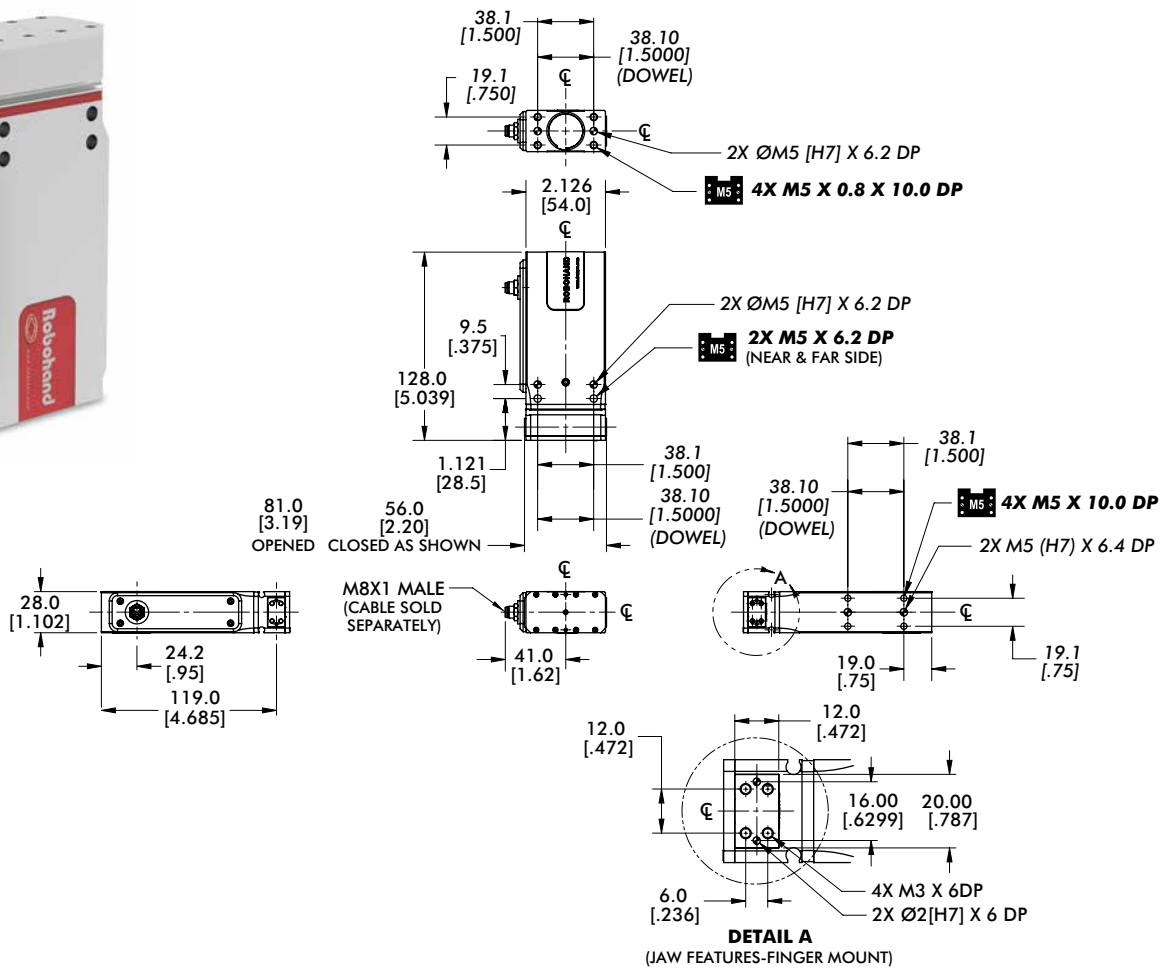

Specifications

Specifications	Units	DPE-200-25
Total Grip Force	N [lbf]	111 [25]
Stroke	mm [in]	25 [0.98]
Repeatability	mm [in]	±0.025 [0.001]
Accuracy	mm [in]	±0.051 [0.002]
Actuation Time	ms	250
Temperature Range	°C [°F]	5°~60° [41°~140°]
Power Requirement @ 100% duty cycle	W	4.2
Voltage	VDC	24
Current - Peak	amps	1.5 (max)
Current - Continuous	amps	0.175
Ingress Protection Class (IP)		IP54
Clean Room		1000 (Krytox)
Weight	kg [lbs]	0.53 [1.16]
Max Finger Length	mm [in]	76.2 [3.00]
Durability	cycles	20 Million

Loading Information

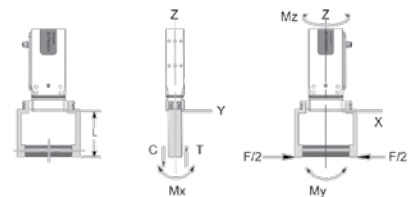
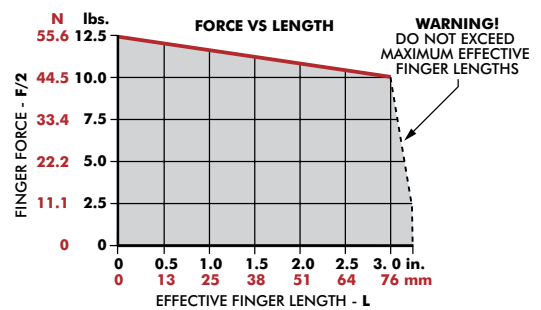

DPE-200-25	Static
Maximum Tensile T	10 N [75 lbs]
Maximum Compressive C	10 N [75 lbs]
Maximum Moment M_x	14 Nm [120 in-lbs]
Maximum Moment M_y	17 Nm [150 in-lbs]
Maximum Moment M_z	14 Nm [120 in-lbs]

*Capacities are per set of jaws and are not simultaneous

RPE-100 LIGHT-DUTY

Electric Parallel Grippers | Features and Benefits | How To Order

Features:

- Ideal for semiconductor and life sciences laboratory applications
- Compact design allows several units mounted closely together to grip multiple parts simultaneously
- Fully integrated electronics, no programming or software. Operates from PLC discrete open/close commands
- Fail-safe operation with spring closed maintains full grip force upon power loss
- No programming required. Gripper actuates using a 50ms discrete pulse from PLC or controller
- Minimized finger backlash and side play with low friction Dual-V bearing system
- Maintenance free internally lubricated and sealed
- Clean room 100 rated IP54

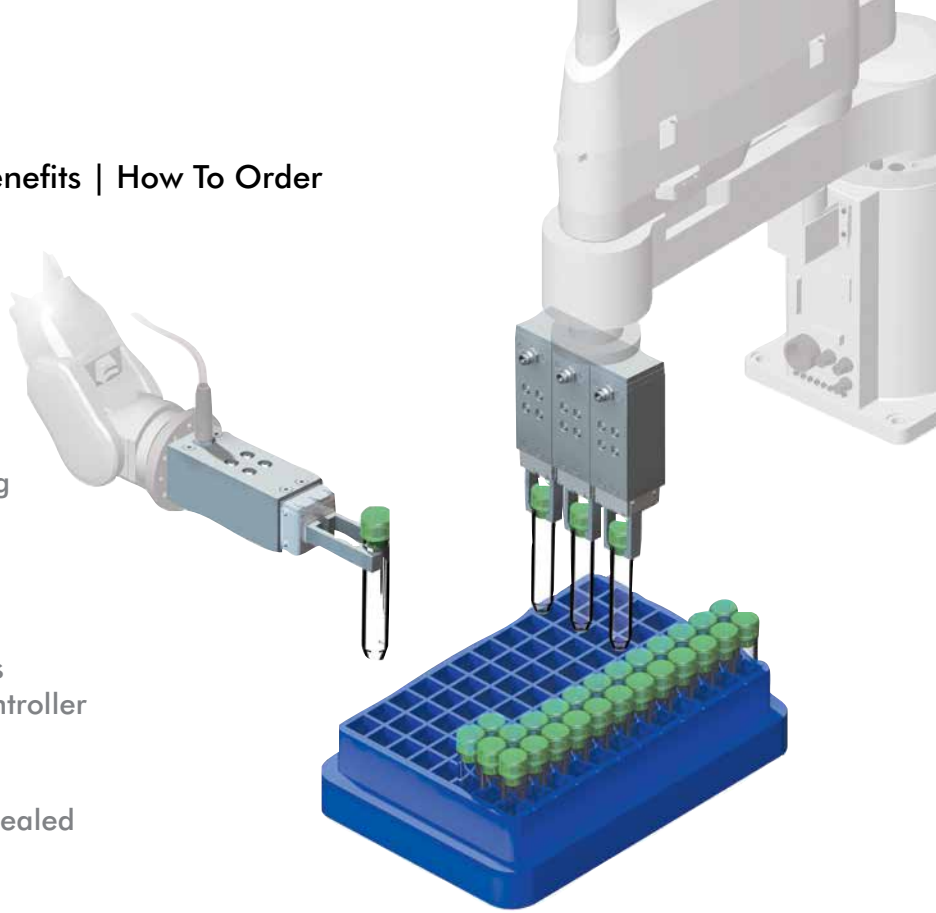

How To Order

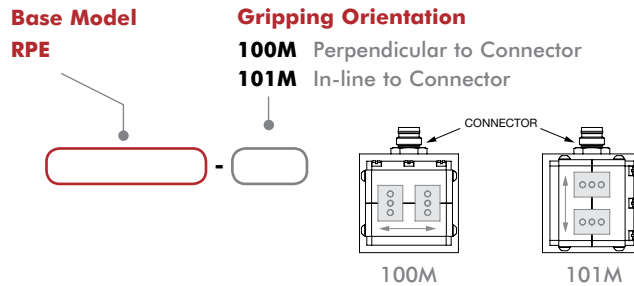

Accessories

Sensor Accessories	Part Number
Inductive Sensor Mounting Kit (Mounts 1 sensor)	OSMK-130
PNP Inductive Sensor with Quick Connect	OISP-019
NPN Inductive Sensor with Quick Connect	OISN-019
Quick Disconnect Sensor Cable, 2m long	CABL-010
Quick Disconnect Sensor Cable, 5m long	CABL-013

*Sensor and cable sold separately.

Electrical Interface: Pin Out

(Looking into the head of the connector on gripper)

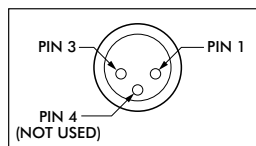

PIN ORIENTATION

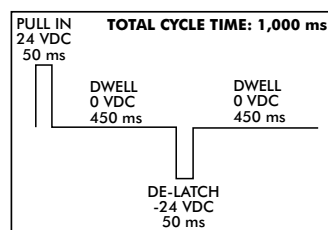

TIMING DIAGRAM

RPE-100 LIGHT-DUTY

Electric Parallel Grippers | Dimensions and Technical Specifications

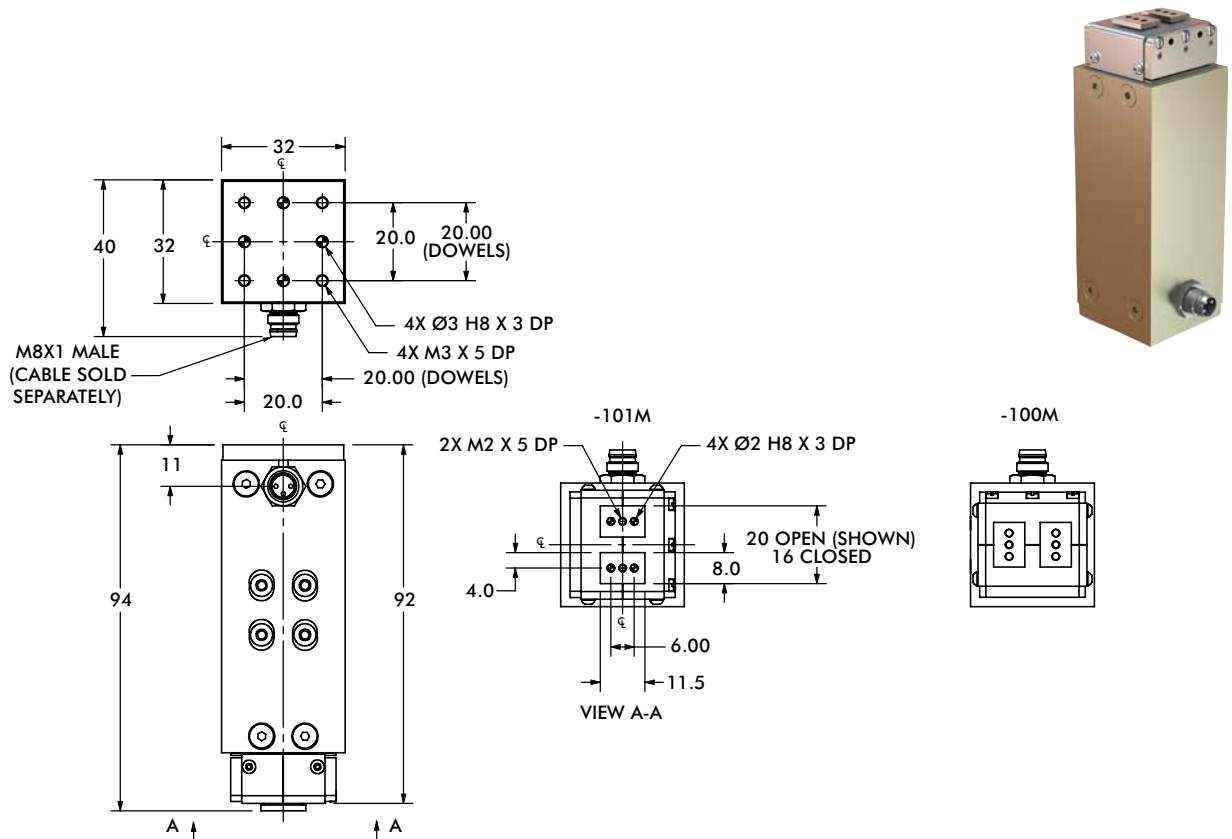

Specifications

Specifications	Units	RPE-100M/101M
Total Grip Force	N [lbf]	5 [1.1]
Stroke	mm [in]	4 [0.16]
Repeatability	mm [in]	±0.025 [0.001]
Accuracy	mm [in]	±0.051 [0.002]
Actuation Time	ms	100
Temperature Range	°C [°F]	5°~50° [40°~120°]
Power Requirement @ 100% duty cycle	W	40 (Peak)
Voltage	VDC	24
Current - Peak	amps	1.5 (max)
Current - Continuous	amps	0.175
Ingress Protection Class (IP)		IP54
Clean Room		100 (Krytox)
Weight	kg [lbs]	0.23 [0.50]
Max Finger Length	mm [in]	50 [1.90]
Durability	cycles	5 Million

Loading Information

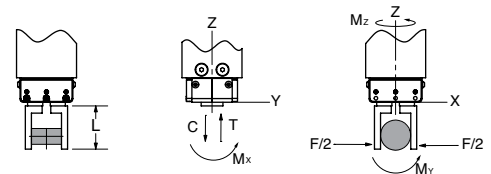
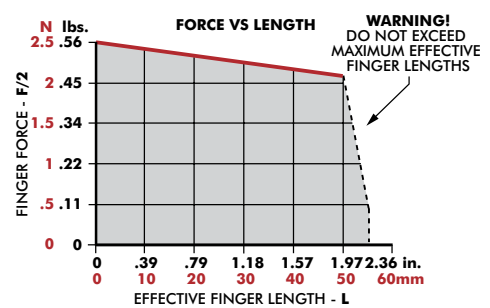

	Static	Dynamic
Maximum Tensile T	59 N [13 lbs]	20 N [4.5 lbs]
Maximum Compressive C	59 N [13 lbs]	20 N [4.5 lbs]
Maximum Moment M_x	0.75 Nm [2.7 lbf-in]	0.3 Nm [6.6 lbf-in]
Maximum Moment M_y	1.2 Nm [10.6 lbf-in]	0.4 Nm [3.5 lbf-in]
Maximum Moment M_z	0.75 Nm [6.6 lbf-in]	1.1 Nm [9.7 lbf-in]

[†]Capacities are per set of jaws and are not simultaneous