

### PZ Series Load Sensitive Variable Piston Pump

35 to 220cm<sup>3</sup>/rev  
21MPa

### Features

- ① The PZ Series load sensitive variable piston pump employs the semi-cylindrical swash plate that is part of the basic technology used by the PVS series variable piston pump. To this it adds a hydrostatic bearing mechanism, valve plate, and other noise reducing mechanisms for operation that is even quieter than that of PVS Series pumps.
- ② The pump body houses an electro-hydraulic proportional control valve, compensator, and surge cutoff valve, which eliminates the need for superfluous piping.
- ③ The electro-hydraulic proportional

control valve uses the proven force feedback system for improved hysteresis, repeatability, and response.

- ④ The ability to create a double pump configuration with an IP pump further expands the range of possible applications.

### Specifications

#### Pump System Specifications

Model No.	Pump Capacity cm <sup>3</sup> /rev	Maximum Working Pressure MPa {kgf/cm <sup>2</sup> }	Pressure Adjustment Range MPa {kgf/cm <sup>2</sup> }	Flow Control Limit Range ℓ/min Note 3	Revolution Speed min <sup>-1</sup>		Weight kg	Fixed Discharge Pump Note 1	
					Min.	Max.		Capacity cm <sup>3</sup> /rev	Pressure MPa {kgf/cm <sup>2</sup> }
PZ-2B-* 35E1A-11 2 3	35	21 {214}	2 to 7 {20.4 to 71.4 } 2 to 14 {20.4 to 143 } 2 to 21 {20.4 to 214 }	1 to 63	600	2000	36	3.6 to 8.18	21 {214}
PZ-2B-* 45E1A-11 2	45	14 {143}	2 to 7 {20.4 to 71.4 } 2 to 14 {20.4 to 143 }	1 to 80	600	2000	36	3.6 to 8.18	21 {214}
PZ-3B-* 70E1A-10 2 3	70	21 {214}	2 to 7 {20.4 to 71.4 } 2 to 14 {20.4 to 143 } 2 to 21 {20.4 to 214 }	1 to 126	600	1800	60	3.6 to 15.8	21 {214}
PZ-4B-* 100E1A-10 2 3	100	21 {214}	2 to 7 {20.4 to 71.4 } 2 to 14 {20.4 to 143 } 2 to 21 {20.4 to 214 }	1 to 180	600	1800	76	3.6 to 15.8	21 {214}
PZ-5B-* 130E1A-10 2 3 (Note 2)	130	21 {214}	2 to 7 {20.4 to 71.4 } 2 to 14 {20.4 to 143 } 2 to 21 {20.4 to 214 }	3 to 234	600	1800	100	3.6 to 32.3	21 {214}
PZ-6B-* 180E1A-20 2 3	180	21 {214}	2 to 7 {20.4 to 71.4 } 2 to 14 {20.4 to 143 } 2 to 21 {20.4 to 214 }	3 to 324	600	1800	160	3.6 to 63.9	21 {214}
PZ-6B-* 220E1A-20 2 3	220	21 {214}	2 to 7 {20.4 to 71.4 } 2 to 14 {20.4 to 143 } 2 to 21 {20.4 to 214 }	3 to 330	600	1500	162	3.6 to 63.9	21 {214}

Note1. Can be used in combination with an IP pump to configure a fixed discharge pump.

Note2. The PZ-4B-130 model number was changed to PZ-5B-130.

Note3. Maximum flow rate depends on the revolution speed. Values in the above table are for a speed of 1800min<sup>-1</sup> for the PZ-2B to PZ-6B-180, and 1500min<sup>-1</sup> for the PZ-6B-220.

#### Pressure/Flow Rate Control System Specifications

##### Pressure Control System

Pressure Control Range MPa {kgf/cm <sup>2</sup> }	1 : 2 to 7 {20.4 to 71.4 } 2 : 2 to 14 {20.4 to 143 } 3 : 2 to 21 {20.4 to 214 }
Rated Current mA	800
Coil Resistance Ω	20(20°C)
Hysteresis %	3% max. Note 1

##### Flow Rate Control System

Valve Differential Pressure MPa {kgf/cm <sup>2</sup> }	1 {10} Note 2
Rated Current mA	800
Coil Resistance Ω	20(20°C)
Hysteresis %	3% max. Note 1

Note 1. Value when a Nachi-Fujikoshi special amplifier is used (with dithering).

Note 2. Pressure differential of pump discharge pressure (valve IN side) and load pressure (valve OUT side).

Note 3. For information about power amplifiers, see pages I-26 through I-37.

PZ-2B/3B/5B

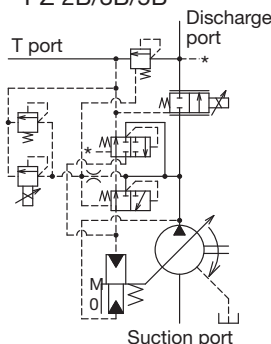

PZ-4B-100

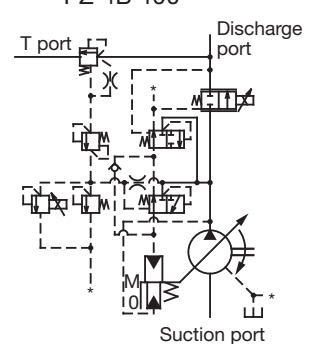

PZ-6B

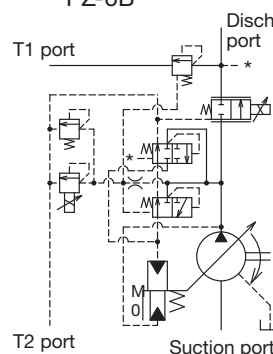

## Explanation of model No.

**PZ - 3 B - 10 - 70 E 2 A - 10**

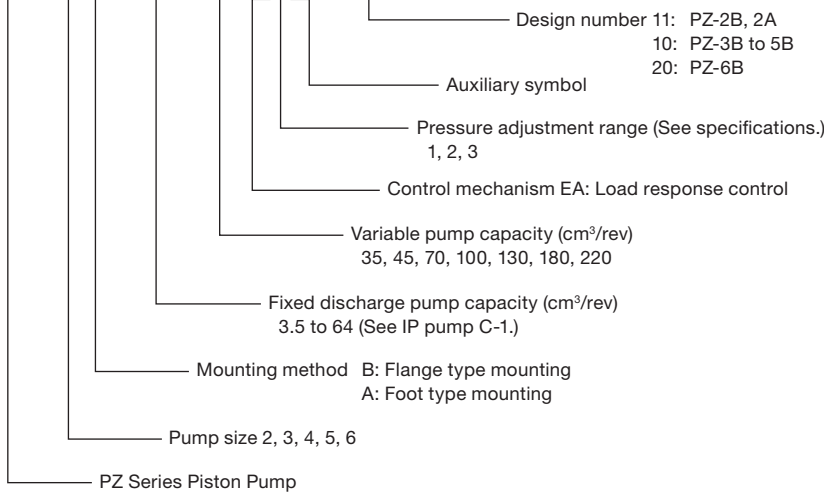

### ● Handling

#### ● Pump Installation and Piping Precautions

- 1 Use flexible couplings for connecting the pump shaft to the drive shaft, and prevent radial or thrust load from being applied to the pump shaft.
  - 2 Eccentricity between the drive shaft and pump shaft should be no greater than 0.05mm, with an eccentric angle error of 1° or less.
  - 3 Keep the fitting length of couplings and pump shafts at least 2/3 the length of the coupling width.
  - 4 Use a sufficiently rigid pump mounting base.
  - 5 Set pump suction side pressure to -0.03 MPa or more (suction port flow velocity less than 2 m/sec).
  - 6 Raise part of the drain piping so it is above the topmost part of the pump body, and insert the return section of the drain piping into the hydraulic operating fluid. Also, observe the values in the following table in order to limit the drain back pressure to 0.1 MPa
- | Item<br>Model No. | PZ-2B              | 3B<br>PZ-4B<br>5B  | PZ-6B              |
|-------------------|--------------------|--------------------|--------------------|
| Pipe Joint Size   | At least 1/2"      | At least 3/4"      | At least 1"        |
| Pipe I.D.         | At least $\phi 12$ | At least $\phi 17$ | At least $\phi 22$ |
| Pipe Length       | 1 m or less        | 1 m or less        | 1 m or less        |
- 7 Mount the pump so the pump shaft is oriented horizontally.
  - 8 Use of rubber hose is recommended in order to minimize noise and vibration.

#### ● Management of Hydraulic Operating Fluid

- 1 Use only good-quality hydraulic operating fluid with a kinematic viscosity during operation within the range of 20 to 200 mm<sup>2</sup>/sec. Normally, you should use an R&O type and wear-resistant type of ISOGV32 to 68 or equivalent. The optimum kinematic viscosity during operation is 20 to 50 mm<sup>2</sup>/sec.
- 2 The operating temperature range is 5 to 60°C. When the oil temperature at startup is 5°C or less, run the pump at low pressure until the oil temperature reaches 5°C.
- 3 Provide a suction strainer with a filtering grade of about 100 $\mu$  (150 mesh). Provide a return line filter of grade 20 $\mu$ m or less on the return line to the tank. (When the pump is used at a high pressure of 14 MPa or greater, a filter of 10 $\mu$ m or less is recommended.)
- 4 Manage hydraulic operating fluid so contamination is maintained at class NAS10 or lower.
- 5 Use hydraulic operating fluid when the operating ambient temperature is in the range of 0 to 60°C.

#### ● Inverter Drive Precautions

- 1 Set the revolution speed within the range of the pump specification revolution speed.
- 2 Changing the revolution speed may also affect the pump performance curves. Before using the inverter, check if the pressure and motor load factor are within the range of use.

#### ● Startup Precautions

- 1 Before starting up the pump, fill the pump body with clean hydraulic operating fluid through the lubrication port.

Model No.	Oil Amount cm <sup>3</sup>
PZ-2B	650
PZ-3B	1000
PZ-4B	1800
PZ-5B	2200
PZ-6B	3000

- 2 Check to make sure that the rotation direction of the pump is the same as the rotation direction indicated by the arrow on the pump body.
- 3 Air entering the pump or pipes can cause noise or vibration. At startup, set the pump discharge side to a no-load state, and operate the pump in the inching mode to remove any air that might be in the pump or pipes.
- 4 Equip an air bleed valve in circuits where it is difficult to release air before startup. (See "IP Pumps" on page C-13.)
- 5 To enable superior pressure and flow control, loosen the air vent when starting up the pump in order to release any air, and fill the inside of the solenoid with hydraulic operating fluid. You can change the position of the air vent by rotating its cover.
- 6 Before adjusting the manual adjusting screw from the first time or when there is no input current to the valve due to electrical malfunction or some other reason, you can control pump pressure and flow rate by rotating the manual adjusting screw. Normally, the manual adjusting screw should be returned completely to its original position and secured with the lock nut.

# Installation Dimension Drawings

PZ-2B-35  
45

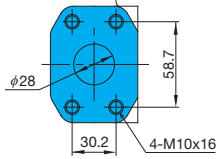
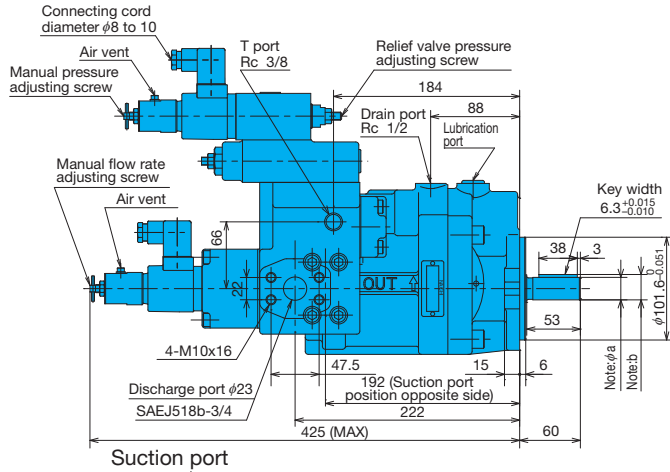

Note

	$\phi a$	b
Single Pump	$\phi 22.23^{0}_{-0.021}$	$24.9^{0}_{-0.5}$
Double Pump with Fixed Flow IP	$\phi 25.385^{0}_{-0.025}$	$27.85^{0}_{-0.25}$

PZ-3B-70

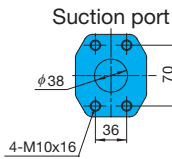
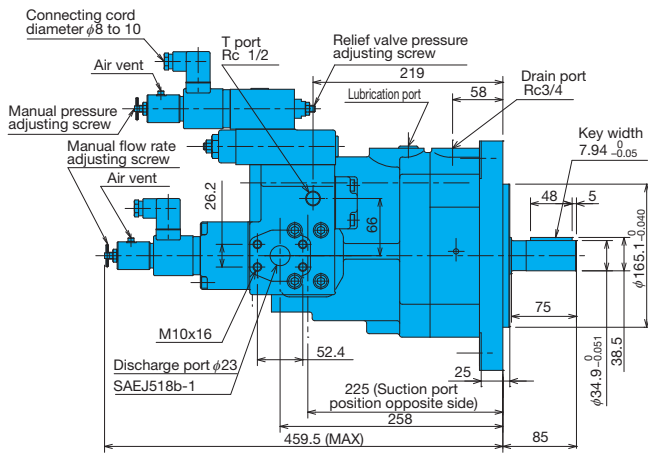

PZ-4B-100

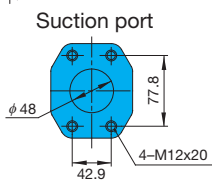
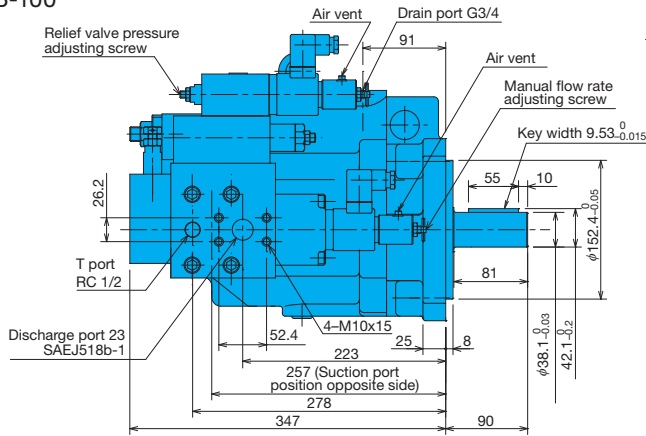

PZ-5B-130

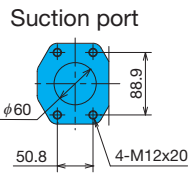
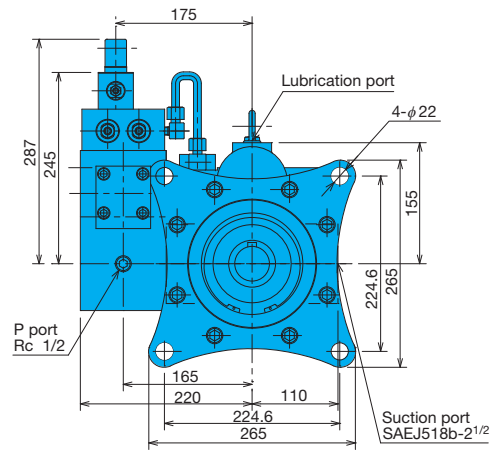
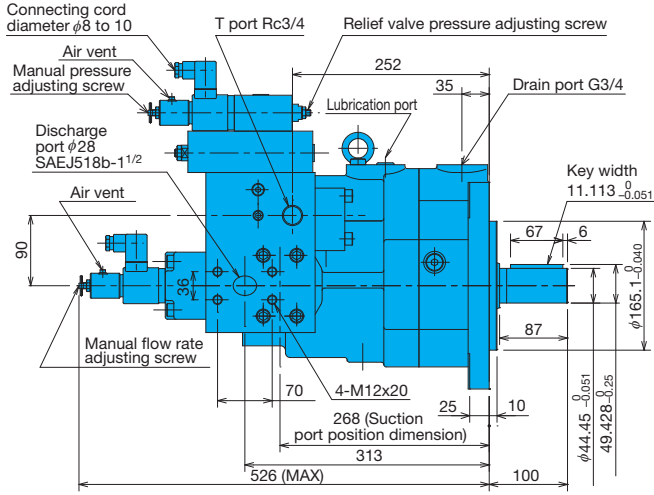

PZ-6B-180  
220

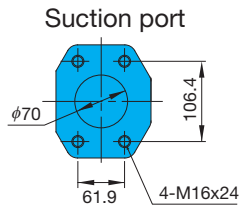
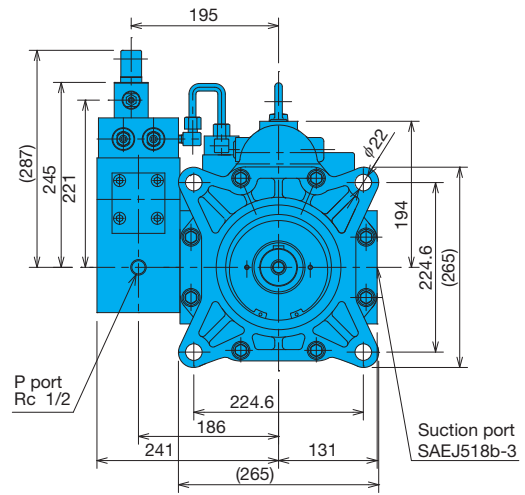
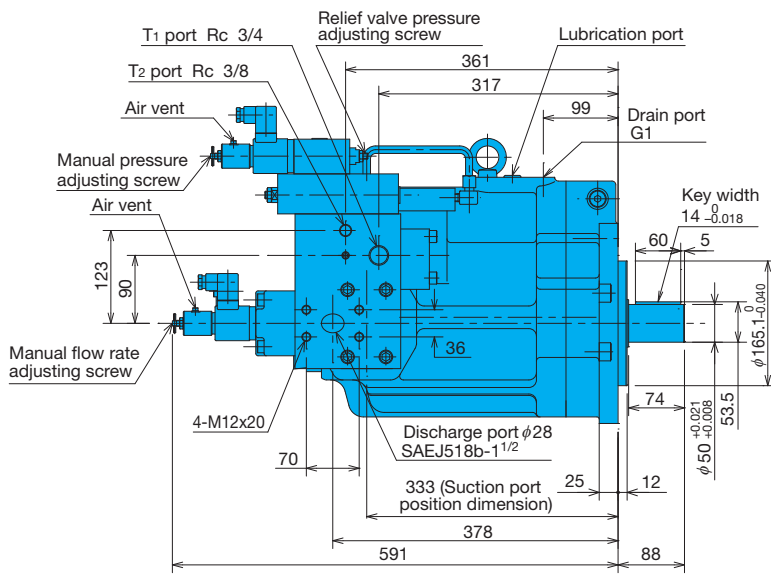

# Performance Curves

Typical characteristics at hydraulic operating fluid kinematic viscosity of 32 mm<sup>2</sup>/s

## Input Current–Discharge Rate Characteristics

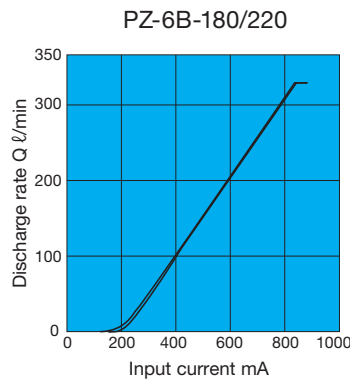
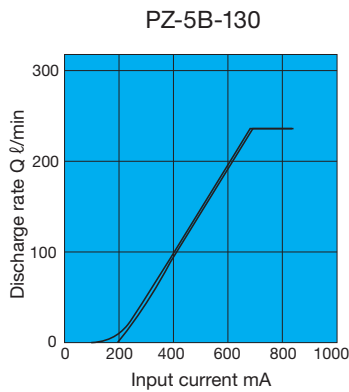
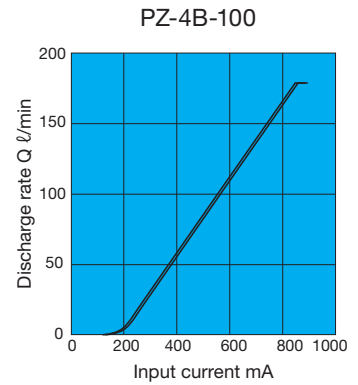
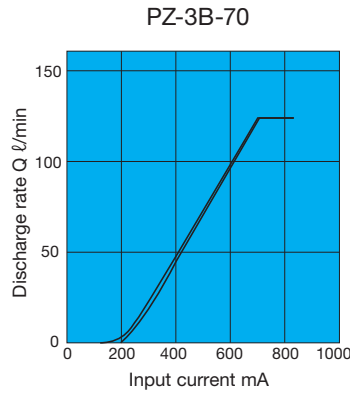
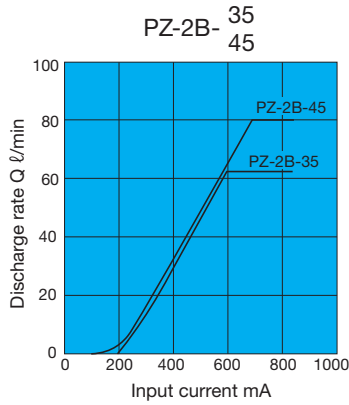

## Input Current–Discharge Pressure Characteristics

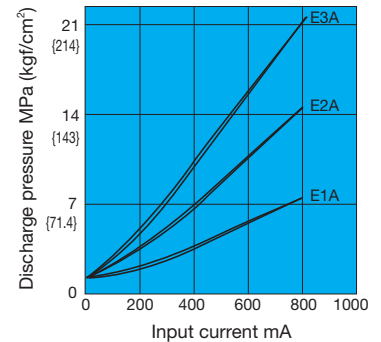

## General Performance

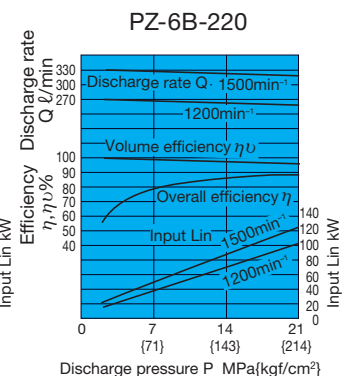
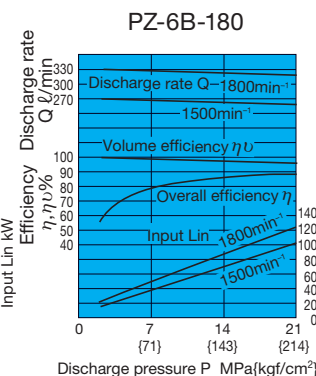
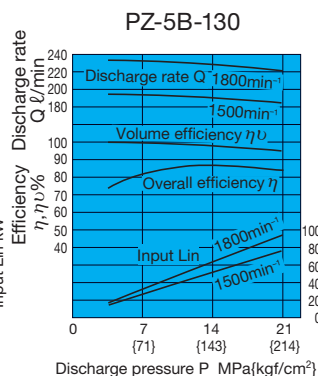
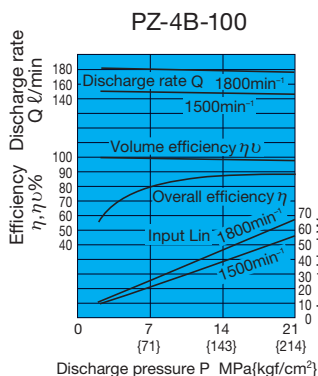
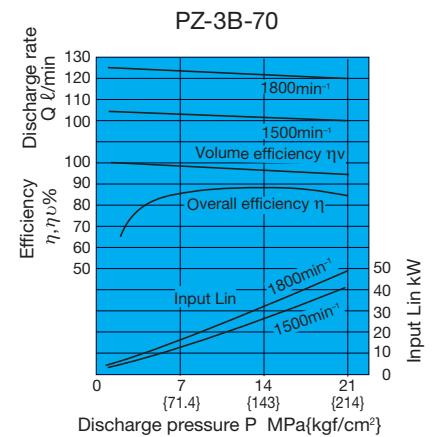
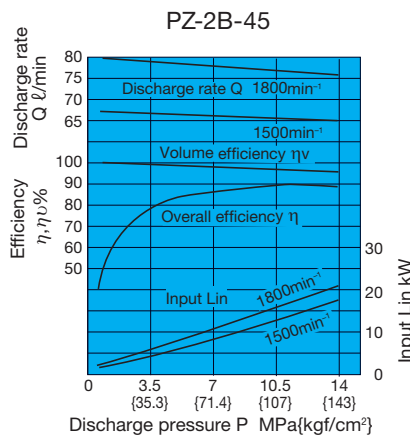
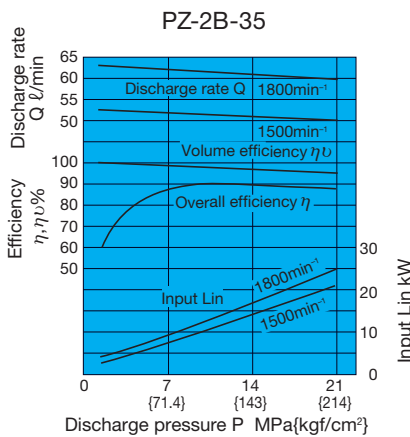

# Cross-sectional Drawings

PZ-2B-35  
45 E\*A-11

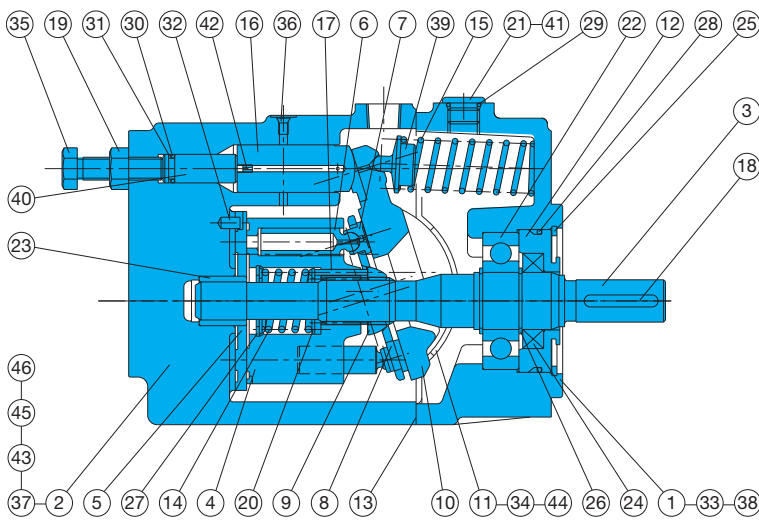

Part No.	Part Name	Part No.	Part Name
1	Body	24	Oil seal
2	Case	25	Snap ring
3	Shaft	26	Snap ring
4	Cylinder barrel	27	Snap ring
5	Valve plate	28	O-ring
6	Piston	29	O-ring
7	Shoe	30	O-ring
8	Shoe holder	31	Backup ring
9	Barrel holder	32	Pin
10	Swash plate	33	Screw
11	Thrust bush	34	Screw
12	Seal holder	35	Screw
13	Gasket	36	Plug
14	Spring C	37	Plug
15	Spring S	38	Plug
16	Control piston	39	Spring holder
17	Needle	40	Guide
18	Key	41	Hydraulic fluid input seal
19	Nut	42	Orifice
20	Retainer	43	Pin
21	Plug	44	Orifice
22	Ball bearing	45	Connector
23	Needle bearing	46	O-ring

### List of Sealing Parts (Kit Model Number PSBS-102220)

Part No.	Part Name	Q'ty	Size	Remarks
* 13	Gasket	1	PS46-102000-0A	3 Bond
24	Oil seal	1	TCN-305011	N. O. K
28	O-ring	1	NBR-90 G70	JIS B 2401
29	O-ring	1	NBR-90 P14	JIS B 2401
30	O-ring	1	NBR-90 P11	JIS B 2401
31	Backup ring	1	T2-P11	JIS B 2407
46	O-ring	2	NBR-90 P5	JIS B 2401

Parts marked by an asterisk "\*" are not available on the market. Consult your agent.

PZ-3/5B-\*E\*A-10

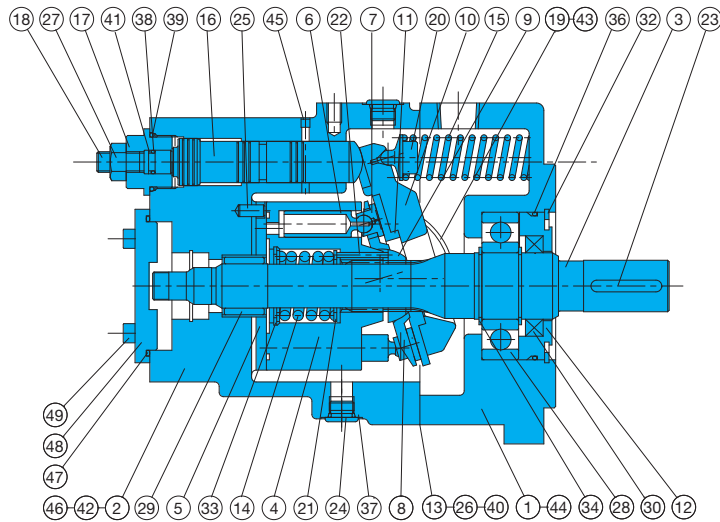

Part No.	Part Name	Part No.	Part Name
1	Body	24	Plug
2	Case	25	Pin
3	Shaft	26	Connector
4	Cylinder barrel	27	Nut
5	Valve plate	28	Ball bearing
6	Piston	29	Needle bearing
7	Shoe	30	Oil seal
8	Shoe holder	32	Snap ring
9	Barrel holder	33	Snap ring
10	Swash plate	34	Snap ring
11	Thrust plate	36	O-ring
12	Seal holder	37	O-ring
13	Gasket	38	O-ring
14	Spring C	39	O-ring
15	Spring S	40	O-ring
16	Control piston	41	Backup ring
17	End plug	42	Bolt
18	Guide screw	43	Screw
19	Thrust bush	44	Plug
20	Spring holder	45	Plug
21	Retainer	46	Pin
22	Needle	47	O-ring
23	Key	48	Plate
		49	Screw

### List of Sealing Parts (Kit Model Number 3B; PZAS-103200, 5B; PZAS-104000)

Part No.	Part Name	PZ-3B		PZ-5B		Remarks
		Size	Q'ty	Size	Q'ty	
13	Gasket	*	1	*	1	3 Bond
30	Oil seal	TCN-456812	1	TCN-608212	1	N. O. K
36	O-ring	NBR-90 G95	1	NBR-90 G125	1	JIS B 2401
37	O-ring	NBR-90 P14	2	NBR-90 P21	2	JIS B 2401
38	O-ring	NBR-90 P12	1	NBR-90 P16	1	JIS B 2401
39	O-ring	NBR-90 P34	1	NBR-90 P42	1	JIS B 2401
40	O-ring	NBR-90 P7	2	NBR-90 P7	2	JIS B 2401
41	Backup ring	T2-P12	1	T2-P16	1	JIS B 2407
47	O-ring	NBR-90 G90	1	NBR-90 G85	1	JIS B 2401

Parts marked by an asterisk "\*" are not available on the market. Consult your agent.

\* Lubrication port changed to GPF 3/8. (from May 2008)



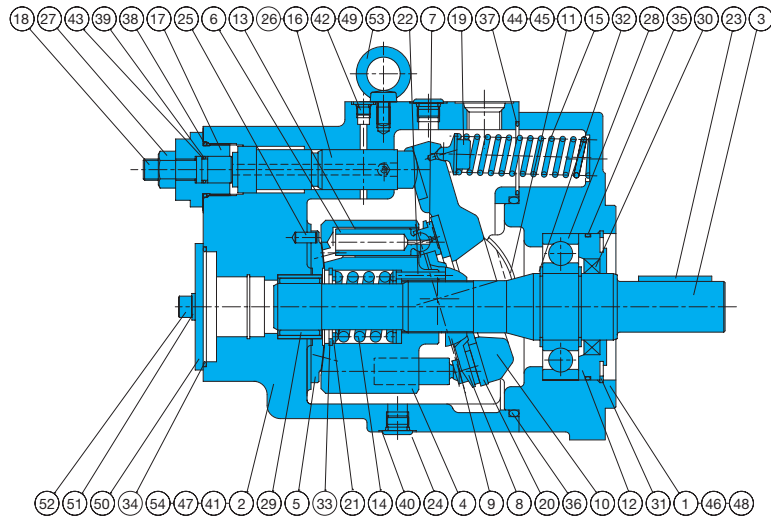

Part No.	Part Name	Part No.	Part Name
1	Body	31	Snap ring
2	Case	32	Snap ring
3	Shaft	33	Snap ring
4	Cylinder barrel	34	O-ring
5	Valve plate	35	O-ring
6	Piston	36	O-ring
7	Shoe	37	O-ring
8	Shoe holder	38	O-ring
9	Barrel holder	39	O-ring
10	Swash plate	40	O-ring
11	Thrust bush	41	O-ring
12	Seal holder	42	O-ring
13	Sleeve	43	Backup ring
14	Spring C	44	Orifice
15	Spring S	45	Screw
16	Control piston	46	Plug
17	End plug	47	Pin
18	Guide screw	48	Bolt
19	Spring holder	49	Plug
20	Thrust plate	50	Plate
21	Retainer	51	Washer
22	Needle	52	Bolt
23	Key	53	Eye bolt
24	Plug	54	Electro-hydraulic proportional valve
25	Pin		
26	Orifice		
27	Nut		
28	Ball bearing		
29	Needle bearing		
30	Oil seal		

List of Sealing Parts (Kit Model Number 4B : PZAS-104100, 6B : PZBS-106000)

Part No.	Part Name	PZ-4B		PZ-6B		Remarks
		Size	Q'ty	Size	Q'ty	
30	Oil seal	TCN-507212	1	TCN-659013	1	N. O. K
34	O-ring	NBR-90 G85	1	NBR-90 G85	1	JIS B 2401
35	O-ring	NBR-90 G105	1	NBR-90 G135	1	JIS B 2401
36	O-ring	NBR-90 G155	1	NBR-90 G200	1	JIS B 2401
37	O-ring	NBR-90 G50	1	NBR-90 G65	1	JIS B 2401
38	O-ring	NBR-90 P36	1	NBR-90 P41	1	JIS B 2401
39	O-ring	NBR-90 P16	1	NBR-90 P16	1	JIS B 2401
40	O-ring	NBR-90 P14	3	NBR-90 P14	3	JIS B 2401
41	O-ring	NBR-90 P9	1	NBR-90 P10	1	JIS B 2401
42	O-ring	NBR-90 P8	5	NBR-90 P8	8	JIS B 2401
43	Backup ring	T2-P16	1	T2-P16	1	JIS B 2407

\* Lubrication port changed to GPF 3/8. (from May 2008)

### Foot Mounting Kit

Pump Model No.	Mounting Model No.
PZ-2B	IHM-44-10
PZ-3B PZ-5B PZ-6B	IHM-55-10
PZ-4B	PZM-4-10

Note: See pages C-12 and A-34 for information about mounting methods.

### Piping Flange Kit

Flange Kit model No.	Applicable Pump Model No.	IN Flange							
		Flange Part No.	Bolt	Washer	O-ring				
IHF -4-T-20	PZ-2B-35/45	IH03J-100100	1	TH-10x55	4	WS-B-10	4	NBR-90 G40	1
IHF -5-T-20	PZ-3B-70	IH03J-100120	1	TH-12x55	4	WS-B-12	4	NBR-90 G50	1
PZF-4-T-10	PZ-4B-100	IH03J-100160	1	TH-12x60	4	WS-B-12	4	NBR-90 G60	1
IHF -7-T-10	PZ-5B-130	IH03J-100200	1	TH-12x60	4	WS-B-12	4	NBR-90 G75	1
PZF-6-T-10	PZ-6B-180/220	IH03J-100240	1	TH-16x75	4	WS-B-16	4	NBR-90 G85	1

OUT Flange								Plug	
Flange Part No.	Bolt	Washer	O-ring						
IH03J-100060	1	TH-10x50	4	WS-B-10	4	NBR-90 G30	1	TPHA-1/4	1
IH03J-100080	1	TH-10x50	4	WS-B-10	4	NBR-90 G35	1	TPHA-1/4	2
IH03J-100080	1	TH-10x50	4	WS-B-10	4	NBR-90 G35	1	TPHA-1/4	1
IH03J-100120	1	TH-12x60	4	WS-B-12	4	NBR-90 G50	1	TPHA-1/4	1
IH03J-100120	1	TH-12x60	4	WS-B-12	4	NBR-90 G50	1	TPHA-1/4	1

Note 1. See page C-11 for dimensions.  
 2. The materials and hardness of the O-ring conform with JIS B2401.  
 3. See page C-11 for details on tightening torque.