

SS Series(Wiring System: Central Terminal Box) Wet Type Solenoid Valve

100 to 160ℓ/min
35MPa

Features

- ① Very long life
The movable iron core of the wet type solenoid is immersed in oil, which keeps it lubricated and cushions it from impact and vibration, ensuring very long life.
- ② Low switching noise
The wet-type solenoid valve provides very low core switching noise, for quiet operation.
- ③ High pressure, large capacity, with minimal pressure loss
Comprehensive fluid reaction force compensation and low pressure
- ④ Easy connections
A special wiring box provides a COM port and indicator light as standard for simple wiring and maintenance.
- ⑤ Easy coil replacement
A plug-in type coil enables one-touch coil replacement.
- ⑥ Wide-ranging backward compatibility makes it simple to replace previous valve models with this one. Combin-

ing this valve with a modular valve contributes to the compact configuration of the overall device.

- ⑦ Compliant with global and international safety regulations (G01 size CE, UL, CSA, and G03 size UL). Can be used safely around the world. Contact us for models and specifications of compliant products.

Specifications

Model No.		SS-G01				SS-G03					
		Standard Type		Shockless Type		Standard Type				Shockless Type	
		Maximum Flow Rate ℓ/min	Maximum Working Pressure MPa(kgf/cm ²)	Maximum Flow Rate ℓ/min	Maximum Working Pressure MPa(kgf/cm ²)	AC Solenoid Type		DC Solenoid Type (With built-in rectifier)		Maximum Flow Rate ℓ/min	Maximum Working Pressure MPa(kgf/cm ²)
Maximum Flow Rate ℓ/min	Maximum Working Pressure MPa(kgf/cm ²)					Maximum Flow Rate ℓ/min	Maximum Working Pressure MPa(kgf/cm ²)				
	-A2X-	30	35	30	25	40	35	85	85	25	25
	-H2X-										
	-E2X-										
	-A3X-	80	35	80	25	85	35	160	160	80	25
	-H3X-										
	-E3X-										
	-A3Z-	65	35	65	25	65	35	160	160	65	25
	-H3Z-										
	-E3Z-										
	-A4-	50	35	50	25	130	35	160	160	50	25
	-H4-										
	-A5-										
	-H5-	100	35	100	25	130	35	160	160	100	25
	-C2-										
	-C5-										
	-C9-	100	35	100	25	130	35	160	160	100	25
	-C1S-										
	-C6S-										
	-C1-	AC Solenoid 65	35	65	25	70	35	160	160	65	25
	-C6-										
	-C4-	50	35	50	25	70	35	160	160	50	25
	-C7Y-										
	-C8-										

Note) The maximum flow rate of each valve depends on the pressure. For details, see pages E-9 and E-10.

		SS-G01			SS-G03			
		AC Solenoid	DC Solenoid		AC Solenoid	DC Solenoid		
			Built-in Rectifier			Built-in Rectifier		
		C*	E*	D*	C*	E*	D*	
Maximum Working Pressure	P, A, B ports	35(25)MPa{357(255)kgf/cm ² }(Note1)						
Maximum Allowable Backpressure	T port	21MPa{214kgf/cm ² }			16MPa{163kgf/cm ² }			
Switching frequency (cycles/minute)	Standard Type	300	120	300	300	120	240	
	Shockless Type	–		120	–		120	
Standard	Indicator light	R			R			
Option	Shockless	–	F		–	F		
	Surgeless	G	–	G	G	–	G	
	With manual push-button	N			N			
	Quick Return	–	Q	–	–	Q	–	
Weight (kg)	Double Solenoid	1.8	2.0		4.2	5.5		
	Single Solenoid	1.4	1.5		3.5	4.1		
Operating Environment	Dust Resistance/Water Resistance Rank	JIS C 0920 IP64 (Dust-tight, Splash-proof)						
	Ambient Temperature	– 20 to 50°C						
	Operating Fluid	Temperature Range	– 20 to 70°C					
		Kinematic Viscosity Range	15 to 300mm ² /s					
		Filtration	25 μm or less					
Mounting bolt	Size × Length	M5 × 45 (Four)			M6 × 70 (Four) (M8 × 70 (Four))			
	Tightening Torque	M5 5 to 7N·m{51 to 71kgf·cm}			M6 10 to 13N·m{102 to 133kgf·cm} (M8 20 to 25N·m{204 to 255kgf·cm})			

- Note) 1. Maximum operating pressure depends on the valve type. For details, see page E-1.
 2. For mounting bolts, use bolts with 12.9 strength classification or equivalent.
 3. Mounting bolts are not included with the 01 size.
 4. For 03 size installation bolts and spacers are provided. Attach the spacers to the valve to maintain the appropriate fitting length even if you do not use the installation bolts provided to add on modular valves.

● Handling

- 1 In order to realize the full benefits of the wet type solenoid valve, configure piping so oil is constantly supplied to the T(R) port. Never use a stopper plug in the T(R) port.
- 2 Ensure that surge pressure in excess of the maximum allowable back pressure does not reach the T port.
- 3 Note that the maximum flow rate is limited when used as a four-way valve, or by blocking ports for use as a two-way valve or one-way valve.
- 4 Always keep the operating fluid clean. Allowable contamination is class NAS12 or less.
- 5 When using petroleum type operating fluid, use JIS K 2213 Class 1 or Class 2, or equivalent.
- 6 For details about using fire-resistant hydraulic fluid, see page D-1 for more information.
- 7 Use this valve only within the allowable voltage range.
- 8 Do not allow the AC solenoid to become charged until you install the coil into the valve.
- 9 In the case of operation symbols A2X, H2X, and E2X, run drain piping from the valve T port.
- 10 Maintaining a switching position under high pressure for a long period can cause abnormal operation due to hydraulic lockup.

Contact your agent when you need to maintain a switching position for a long period.

- 11 When using a detent type (E2X, 3X, E3Z), use constant energization in order to securely maintain the switching position.

12 Note that manual pin operating pressure changes in accordance with tank line back pressure.

13 The series described in the table below are available for use as RSS and RIS Series solenoid control relief valves.

RSS-***-AR*(H)-** ¹⁵ ₂₃ RIS-***-AR*(H)-** ¹⁵ ₂₁	SS-G01-AR-R-**-31
RSS-***-AQ*(H)-** ¹⁵ ₂₃ RIS-***-AQ*(H)-** ¹⁵ ₂₁	SS-G01-A3X-R-**-31
RSS-***-F(H)-** ¹⁵ ₂₃	SS-G01-A8X0-R-**-31
RIS-***-F-**-21	SS-G01-A3X-R-**-31

- 14 The coil surface temperature increases if this valve is kept continuously energized. Install the valve so there is no chance of it being touched directly by hand.

15 Use the following table for specification when a sub plate is required.

Model No.	Pipe Diameter	Maximum Working Pressure MPa{kgf/cm ² }	Recommended Flow Rate (ℓ/min)	Weight (kg)	Applicable Valve Type
MSA-01X-10	1/4	25{255}	20	1.2	SS-G01-**-R-**-31
MSA-01Y-10	3/8		40		
MSA-03-10	3/8		45	2.3	SS-G03-**-R-**-J22
MSA-03X-10	1/2		80		
MS-03-30	3/8		45	2.3	SS-G03-**-R-**-22
MS-03X-30	1/2		80		

● Solenoid Assembly Specifications

Solenoid Type	Power Supply Type	Voltage (V)	Frequency (Hz)	For SS-G01				For SS-G03						
				Solenoid Coil Type	Drive Current (A)	Holding Current (A)	Holding Power (W)	Allowable Voltage Range (V)	Solenoid Coil Type	Drive Current (A)	Holding Current (A)	Holding Power (W)	Allowable Voltage Range (V)	
AC	C1	AC100	50	EDC64-C1	2.2	0.52	25	80 to 110	ECB64-C1	5.4	0.92	36.0	80 to 110	
			60		2.0	0.38	22	90 to 120		4.6	0.62	34.0		
		AC110	60		2.2	0.46	28			5.0	0.78	42.0	90 to 120	
	C115	AC110	50	EDC64-C115	2.0	0.47	25	90 to 120	ECB64-C115	5.0	0.85	36.0	90 to 120	
			60		1.8	0.35	22	100 to 130		4.2	0.57	34.0		
		AC115	60		2.0	0.42	28			4.6	0.72	42.0	100 to 130	
	C2	AC200	50	EDC64-C2	1.1	0.26	25	160 to 220	ECB64-C2	2.7	0.46	36.0	160 to 220	
			60		1.0	0.19	22	180 to 240		2.3	0.31	34.0		
		AC220	60		1.1	0.23	28			2.5	0.39	42.0	180 to 240	
	C230	AC220	50	EDC64-C230	1.0	0.24	25	180 to 240	ECB64-C230	2.5	0.42	36.0	180 to 240	
			60		0.91	0.17	22	200 to 260		2.1	0.29	34.0		
		AC230	60		1.0	0.21	28			2.3	0.36	42.0	200 to 260	
DC with Built-in Rectifier	E1	AC100	50/60	EDC64-E1-1A	0.31		27	90 to 110	ECB64-E1	0.40		34.0	90 to 110	
			AC110		0.26					25	100 to 125			0.33
		AC115	50/60		0.27									27
	E2	AC200	50/60	EDC64-E2-1A	0.15		26	180 to 220	ECB64-E2	0.22		37.0	180 to 220	
			AC220		0.12					24	200 to 250			0.16
		AC230	50/60		0.13									27
DC	D1	DC12	—	EDC64-D1-1A	2.2		26	10.8 to 13.2	ECB64-D1	2.6		31.0	10.8 to 13.2	
	D2	DC24	—	EDC64-D2-1A	1.1		26	21.6 to 26.4	ECB64-D2	1.5		36.0	21.6 to 26.4	

Explanation of model No.

SS - G 03 - A 3 X - * R - C2 - J22

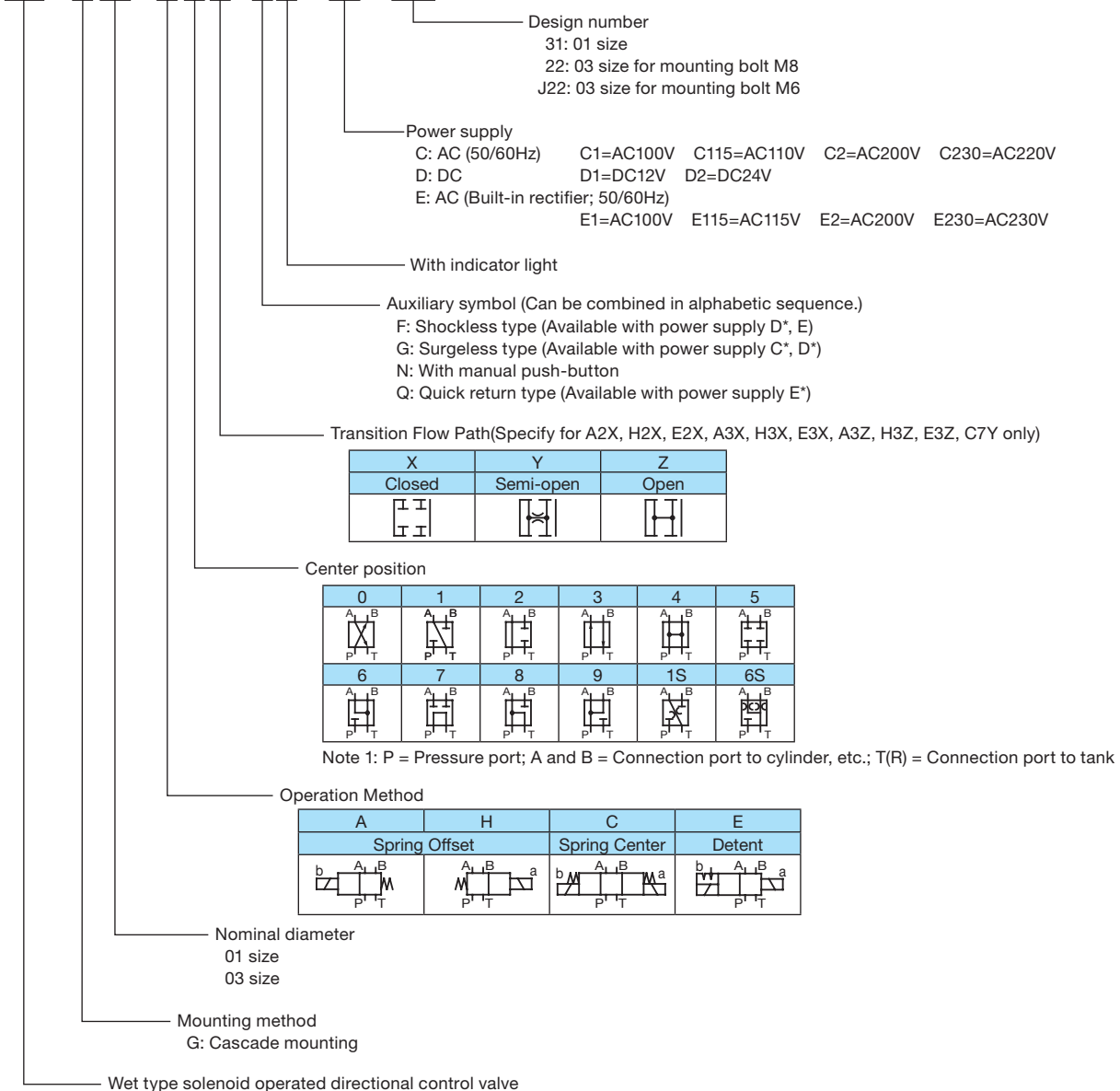

Options

(Auxiliary Symbol Explanations)

Shockless Type (Auxiliary Symbol: F)

Switching Response Characteristics
The pressure waveforms for each valve in the hydraulic circuit shown below are shown at the bottom of this block. Opening and closing of a dry type valve generates shock (noise) and pipe vibration due to the sudden drop or rise in pressure. With a shockless solenoid valve, pressure fluctuation when the valve is opened or closed is smoothed, which eliminates shock (noise) and pipe vibration.

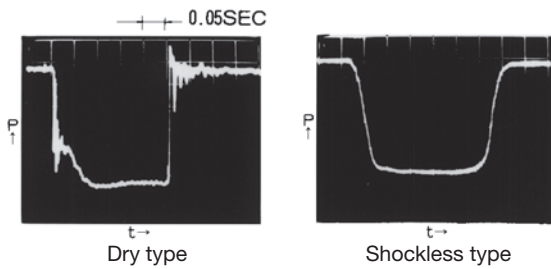
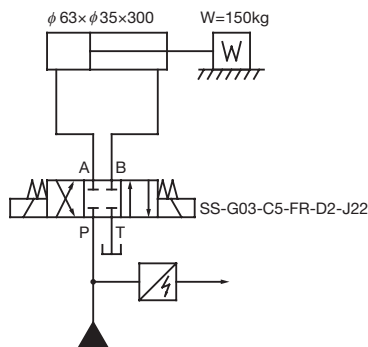

Surgeless Type (Auxiliary Symbol: G)

The surge pressure waveforms when the DC solenoid valve power supply is opened and closed by a relay are shown at the bottom of this block. A built-in surge absorber element eliminates sparking and surge pressure.

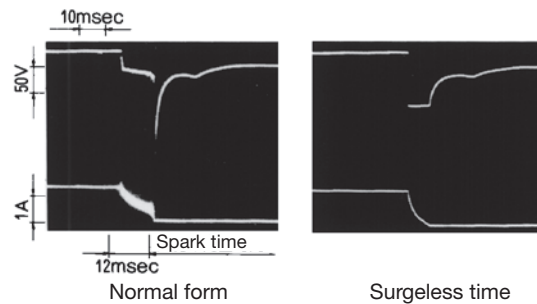
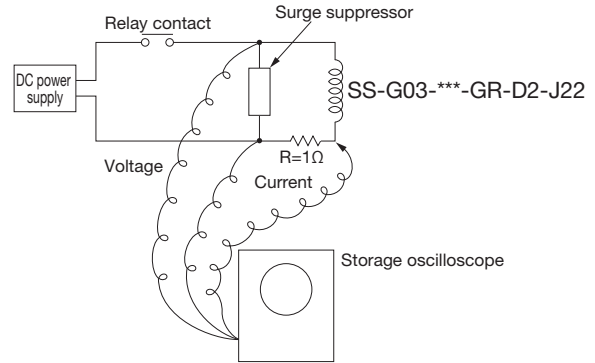

Manual Button Type (Auxiliary Symbol: N)

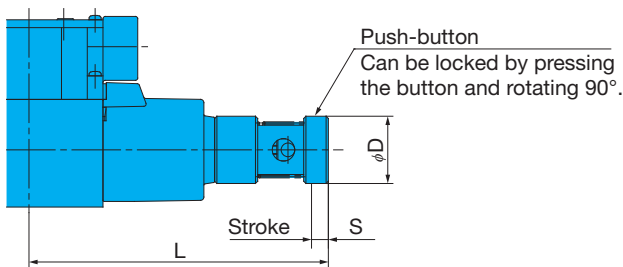

Model No.		L	S	D
SS-G01	AC Solenoid	133.5	7.5	30
	DC Solenoid	140.5		
SS-G03	AC Solenoid	155.5	9.5	35
	DC Solenoid	173.5		

Quick Return (Auxiliary Symbol: Q)

● Handling

- This type is used in the case of power supply type E* (with built-in rectifier) to shorten the spring return time. This also applies to D*.
- Quick return device is built-in to central terminal box.

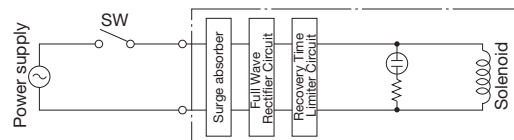

Installation Dimension Drawings

AC Solenoid
 SS-G01-A**-R-C*-31
 SS-G01-H**-R-C*-31

Note) SS-G01-H**-R**-31
 The solenoid is on the opposite side of that shown for SOLa in the illustrations shown here.

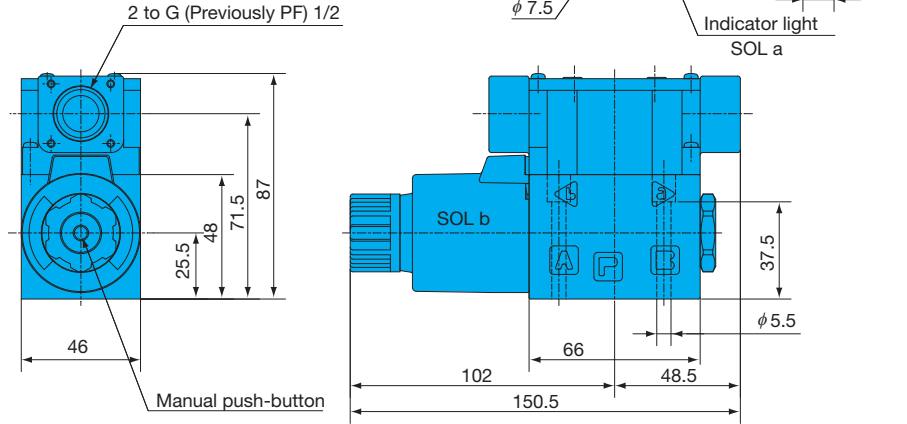

SS-G01-C**-R-C*-31
 SS-G01-E**-R-C*-31

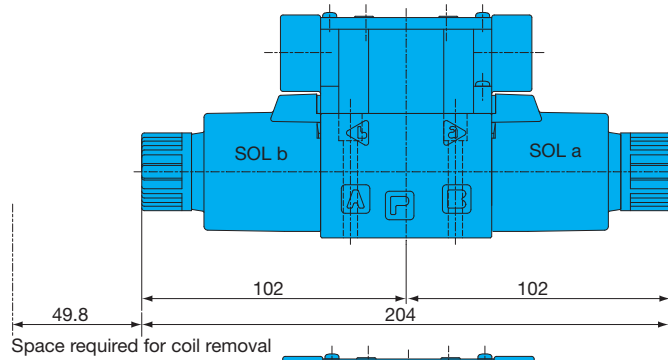

DDC Solenoid and Rectifier
 SS-G01-A**-R-D/E*-31
 SS-G01-H**-R-D/E*-31
 SS-G01-C**-R-D/E*-31
 SS-G01-E**-R-D/E*-31

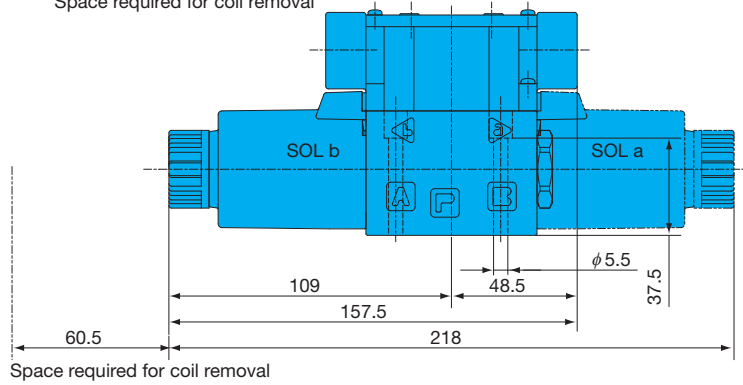

For sub plate SS-G01

Model No.	E	Weight
MSA-01X-10	1/4	1.2kg
MSA-01Y-10	3/8	1.2kg

Gasket Surface Dimensions
 ISO 4401-03-02-0-05
 (JIS B 8355 D-03-02-0-05)

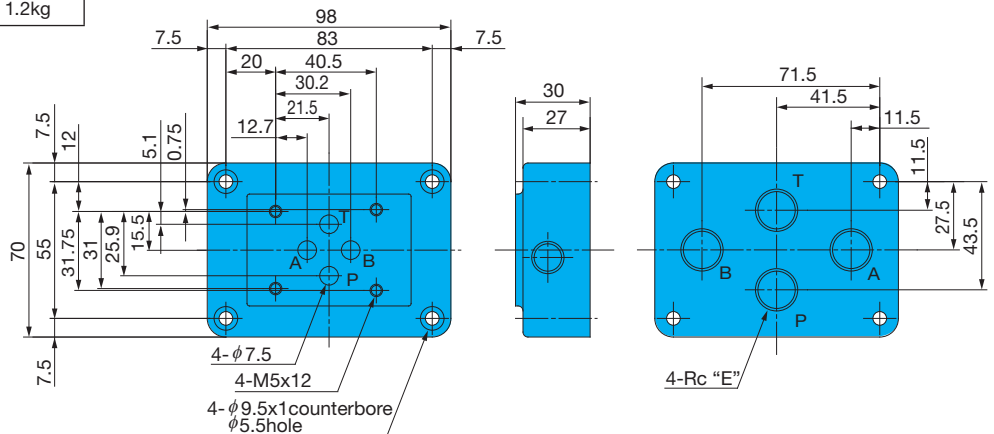

Installation Dimension Drawings

AC Solenoid
 SS-G03-A**-R-C*-J22
 SS-G03-H**-R-C*-J22

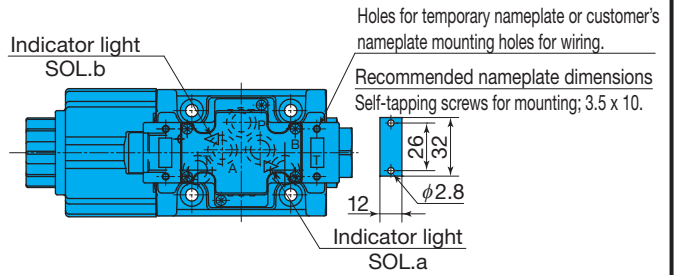

Note 1.) SS-G03-H**-R**-J22
 The solenoid is on the opposite side of that shown for SOL.a in the illustrations shown here.
 Note 2.) Attach the spacers to the valve, as shown in the diagram at right, to maintain the appropriate fitting length even if you do not use the installation bolts provided with the SS-G03.

	SS-G03-**-R**-J22	SS-G03-**-R**-22
ϕD	$\phi 6.8$	$\phi 8.5$
L	60.5	58

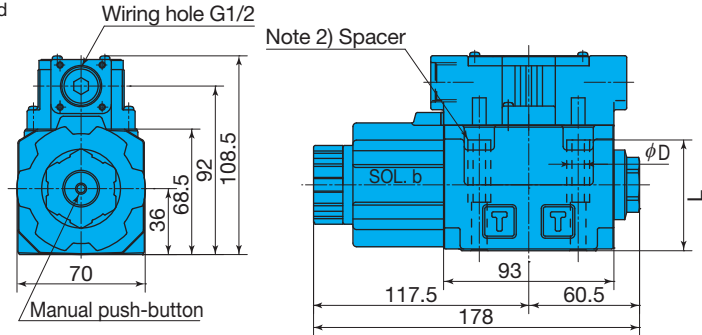

SS-G03-C**-R-C*-J22
 SS-G03-E**-R-C*-J22

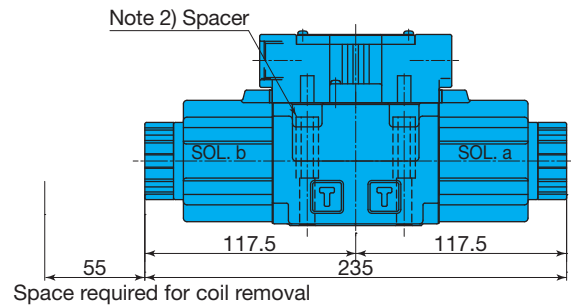

DC Solenoid and Rectifier
 SS-G03-A**-R-D*/E*-J22
 SS-G03-H**-R-D*/E*-J22
 SS-G03-C**-R-D*/E*-J22
 SS-G03-E**-R-D*/E*-J22

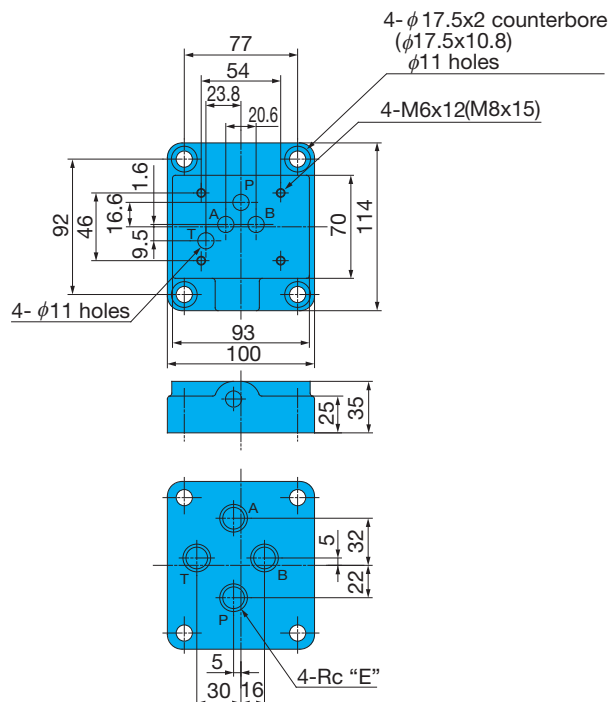
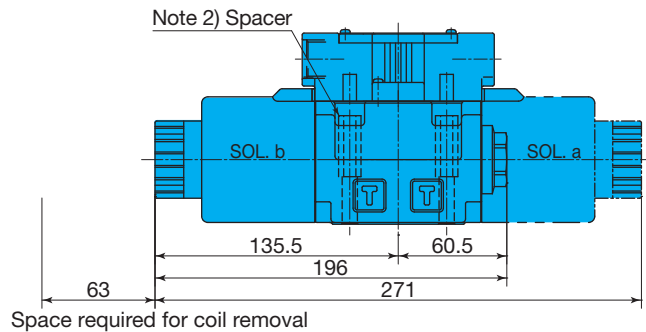

For sub plate SS-G03

Mounting bolt	Model No.	E	Weight
M6	MSA-03-10	3/8	2.3kg
	MSA-03X-10	1/2	
M8	MS-03-30	3/8	
	MS-03X-30	1/2	

M6 gasket surface dimensions
 ISO 4401-05-04-0-05
 (JIS B 8355 D-05-04-0-05)

Wiring Diagram

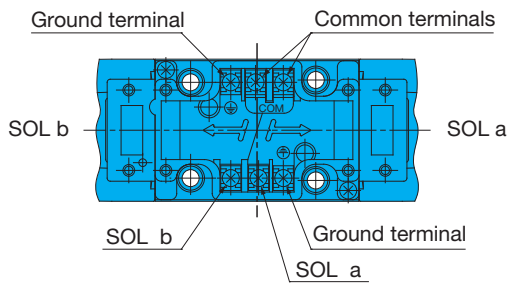

- Note) 1. In the case of a double solenoid valve, a common terminal is provided to simplify wiring. When the common terminal is not used, remove the terminal screws.
 2. Use the ground terminal when grounding is required.
 3. In the case of a solderless terminal, M3 screws.
 4. Tighten terminal screws to a torque of 0.5 to 0.7N-m {5.1 to 7.1kgf-cm}.

Electrical Circuit Diagram

Type	Model No.	Electrical Circuit
AC Solenoid	SS-G01-***-R-C*- 31 G03 J22	
AC Solenoid Surgeless Type	SS-G01-***-GR-C*- 31 G03 J22	
Built-in Rectifier	SS-G01-***-R-E*- 31 G03 J22	
DC Solenoid	SS-G01-***-R-D*- 31 G03 J22	
DC Solenoid Surgeless Type	SS-G01-***-GR-D*- 31 G03 J22	
Built-in Rectifier Quick Return Type	SS-G01-***-QR-E*- 31 G03 J22	See page E-4 for more information.



Performance Curves

Hydraulic Operating Fluid Kinematic Viscosity 32mm²/s

Pressure Loss Characteristics

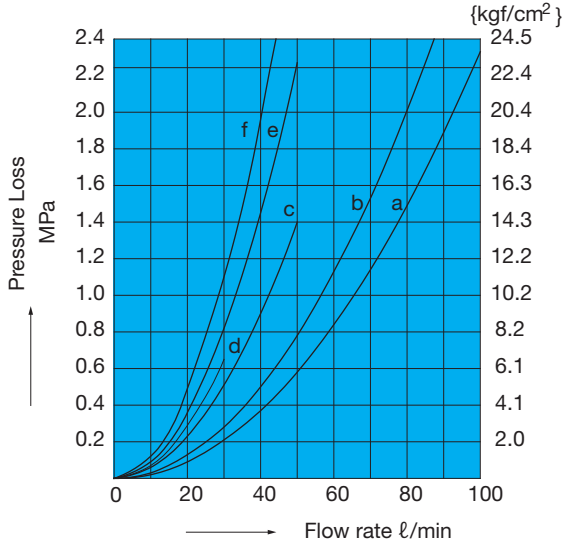

Pump Type	Flow Path	P→A	P→B	A→T	B→T	P→T
SS-G01	A2X, H2X, E2X	d	d	-	-	-
	A3X, H3X	b	b	b	b	-
	E3X	b	b	b	b	-
	A3Z, H3Z, E3Z	a	a	a	a	-
	A4, H4, C4	a	a	a	a	a
	A5, H5, C5, C6S	b	b	b	b	-
	C1, C1S	b	b	a	b	-
	C2	a	b	b	b	-
	C6	b	b	a	a	-
	C7Y	f	f	e	e	c
C8	a	f	b	e	c	
C9	a	a	b	b	-	

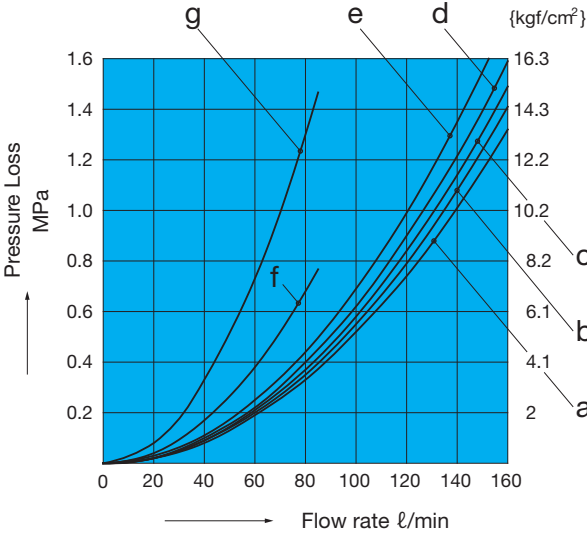

Pump Type	Flow Path	P→A	P→B	A→T	B→T	P→T
SS-G03	A2X, H2X, E2X	e	e	-	-	-
	A5	-	c	c	-	-
	H5	c	-	-	c	-
	A3X, H3X, E3X	c	c	d	d	-
	A3Z, H3Z	a	a	d	d	-
	E3Z	b	b	a	a	-
	C1	c	c	a	c	-
	C2	a	c	c	c	-
	A4, H4, C4	a	a	a	a	a
	C5, C1S, C6S	c	c	c	c	-
	C6	c	c	a	a	-
	C7Y	g	g	g	g	f
	C8	a	g	a	g	f
C9	a	a	c	c	-	

Switching Response Time

Model No.	Response Time (sec)		Measurement Conditions
	Solenoid ON	Spring Return	
SS-G01-**-R-C*-31	0.02 to 0.03	0.02 to 0.03	14MPa{143kgf/cm ² } 30l/min
SS-G01-**-(G)R-D*-31	0.03 to 0.04	0.02 to 0.04	
SS-G01-**-R-E*-31	0.03 to 0.04	0.07 to 0.10	
SS-G01-**-F(G)R-D*-31	0.07 to 0.10	0.04 to 0.07	
SS-G01-**-FR-E*-31	0.07 to 0.10	0.10 to 0.15	
SS-G03-**-R-C*-J22	0.02 to 0.03	0.02 to 0.03	14MPa{143kgf/cm ² } 70l/min
SS-G03-**-(G)R-D*-J22	0.06 to 0.09	0.03 to 0.05	
SS-G03-**-R-E*-J22	0.07 to 0.10	0.10 to 0.15	
SS-G03-**-F(G)R-D*-J22	0.13 to 0.15	0.08 to 0.15	
SS-G03-**-FR-E*-J22	0.10 to 0.15	0.15 to 0.20	

Note) 1. The switching response time changes slightly with operating conditions (pressure, flow rate, viscosity, etc.)

2. In the case of power supply type E* (with built-in rectifier), the spring return time using Quick Return (option symbol: Q) is the same as D*.

Solenoid Valve

Pressure – Flow Volume Allowable Value

Size	Standard Form, with AC, DC solenoid		
	SS-G01-**-R**-31		
Operation Example			
Operation Symbol			
A2X, H2X	-	K	K
E2X	-	J	J
A3X, H3X	B	K	K
E3X	A	J	J
A3Z, H3Z	D	D	D
E3Z	D	D	D
A5	A	-	I
H5	A	I	-
C1, C6	Note1) C(E)	I	I
C1S, C5, C6S	A	I	I
C2, C9	A	K	K
A4	F	F	F
H4	F	F	F
C4	F	F	F
C7Y, C8	Note2) G(H)	K	K

Size	Shockless Type, with DC solenoid		
	SS-G01-**-FR**-31		
Operation Example			
Operation Symbol			
A2X, H2X	-	P	P
E2X	-	O	O
A3X, H3X	L	P	P
E3X	L	O	O
A3Z, H3Z	L	L	L
E3Z	L	L	L
A5	L	-	P
H5	L	P	-
C1, C6	M	P	P
C1S, C2, C5, C6S, C9	L	P	P
A4, H4	L	L	L
C4	L	L	L
C7Y, C8	N	P	P

Note) 1. Letter in parentheses is for AC solenoid.
 2. Letter in parentheses is for solenoid with built-in rectifier (E*), but without Quick Return, and for DC solenoid (D*) with surge voltage absorbing diode on the electrical circuit.

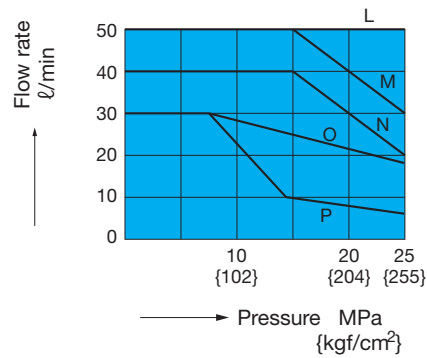
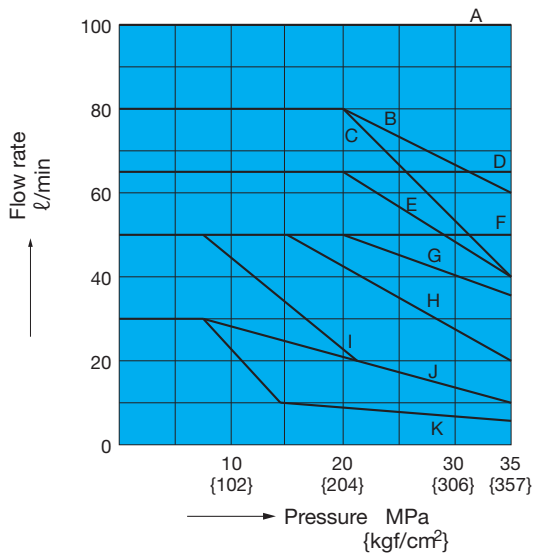

Pressure – Flow Volume Allowable Value

Model No.	Standard Form, with AC Solenoid			Standard Form, with DC Solenoid		
	SS-G03-**-R-C*-J22			SS-G03-**-R-**-J22		
Operation Example						
Operation Symbol						
A2X	-	F	E	-	G	H
H2X	-	E	F	-	H	G
E2X	-	C	C	-	D	D
A3X	A	E	E	A	F	H
H3X	A	E	E	A	H	F
A3Z	A	A	C	A	D	D
H3Z	A	C	A	A	D	D
E3X, E3Z	A	C	C	A	D	D
A5	A	-	D	A	-	G
H5	A	D	-	A	G	-
C1S, C5, C6S	A	D	D	A	G	G
C1, C6	A	D	D	B	G	G
C2	A	G	D	A	I	G
A4, H4, C4	A	A	A	A	A	A
C9	A	G	G	A	I	I
C7Y, C8	B	B	B	Note1) C(E)	C(E)	C(E)
Model No.	Shockless Type, with DC solenoid					
	SS-G03-**-FR-**-J22					
Operation Example						
Operation Symbol						
A2X	-	E	F			
H2X	-	F	E			
E2X	-	C	C			
A3X	A	D	F			
H3X	A	F	D			
A3Z	A	C	C			
H3Z	A	C	C			
E3X, E3Z	A	C	C			
A5	A	-	E			
H5	A	E	-			
C1, C1S, C5, C6, C6S	A	E	E			
C2	A	G	E			
A4, H4, C4	A	A	A			
C9	A	G	G			
C7Y, C8	Note1) B(H)	B(H)	B(H)			

- Note) 1. Letter in parentheses is for solenoid with built-in rectifier (E*), but without Quick Return, and for DC solenoid (D*) with surge voltage absorbing diode on the electrical circuit.
 2. There is no shockless type for the AC solenoid (C*), so use a solenoid with built-in rectifier (E*) when shockless operation is required with an AC power supply.
 3. The maximum flow rate is the allowable value of each port.

Cross-sectional Drawings

SS-G01-A**-R-C*-31

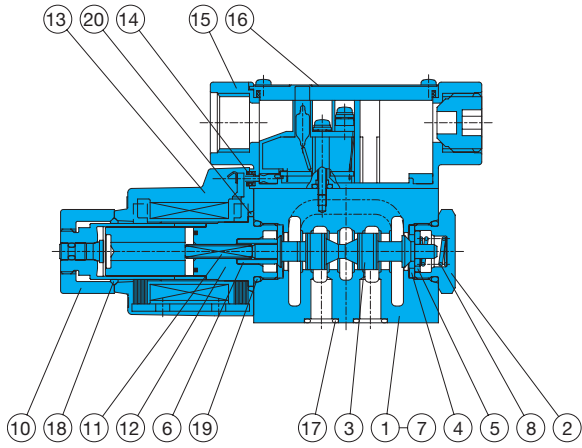

SS-G01-C**-R-C*-31

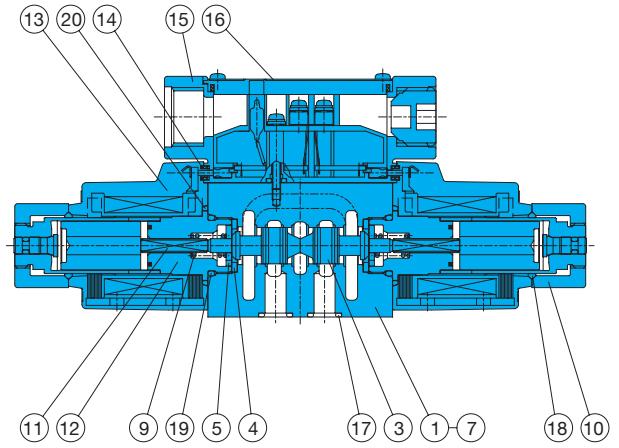

SS-G01-A**-R-D/E*-31

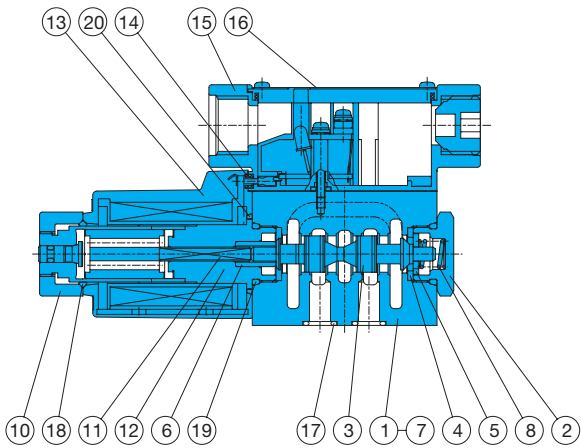

SS-G01-C**-R-D/E*-31

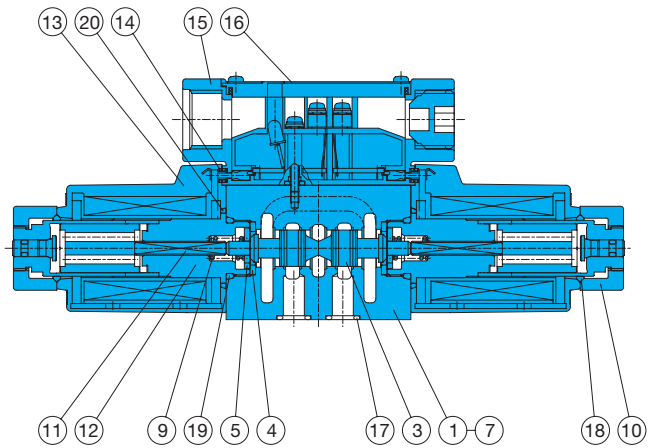

List of Sealing Parts

Part No.	Part Name	Part Number	Q'ty	
			Single Solenoid	Double Solenoid
17	O-ring	AS568-012(NBR-90)	4	4
18	O-ring	NBR-70-1 P20	1	2
19	O-ring	NBR-90 P18	2	2
20	O-ring	S-25(NBR-70-1)	1	2

Note) The materials and hardness of the O-ring conforms with JIS B2401.

Seal Kit Number

Single Solenoid	Double Solenoid
EDCS-A	EDCS-C

Part No.	Part Name	Part No.	Part Name
1	Body	11	Rod
2	Plug	12	Solenoid guide
3	Spool	13	Solenoid coil
4	Retainer A	14	Packing
5	Retainer B	15	Terminal box kit
6	Retainer C	16	Nameplate
7	Spacer	17	O-ring
8	Spring A	18	O-ring
9	Spring C	19	O-ring
10	Nut	20	O-ring



Cross-sectional Drawings

SS-G03-A**-R-C*-J22

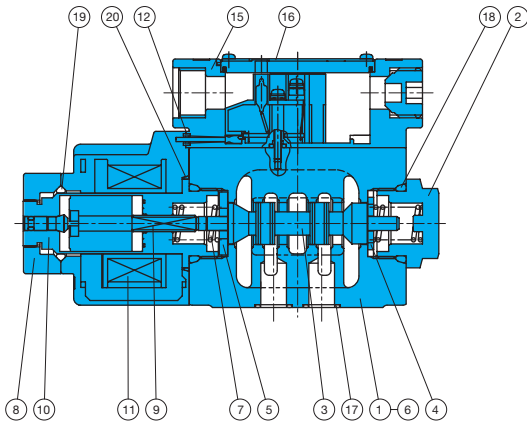

SS-G03-C**-R-C*-J22

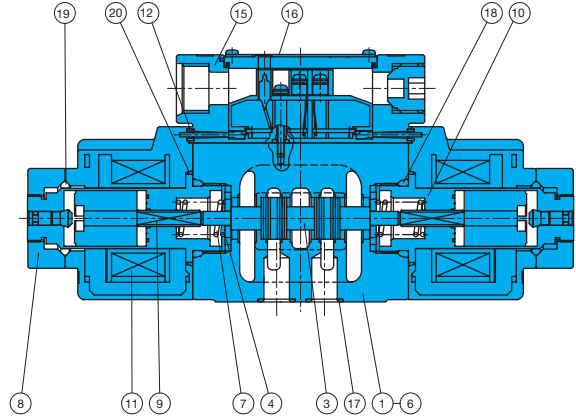

SS-G03-A**-R-D/E*-J22

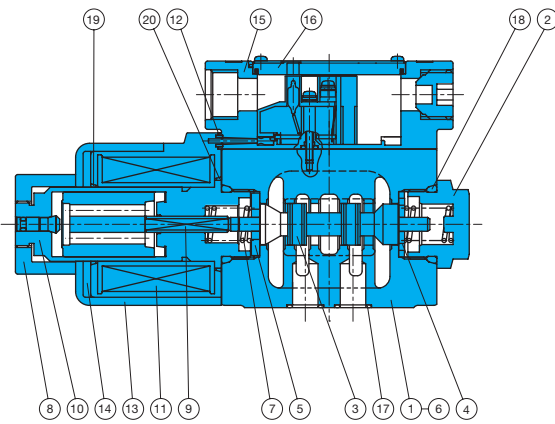

SS-G03-C**-R-D/E*-J22

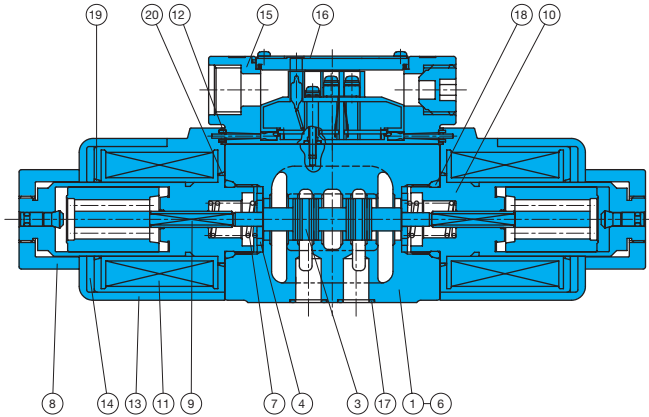

List of Sealing Parts

Part No.	Part Name	Type/Part Number		Q'ty	
		AC SOL.	DC SOL.	Single Solenoid	Double Solenoid
17	O-ring	AS568-014(NBR-90)		5	5
18	O-ring	NBR-90 P28		2	2
19	O-ring	NBR-70-1 P26	AS568-026(NBR-70-1)	1	2
20	O-ring	AS568-029(NBR-70-1)		1	2

Note) The materials and hardness of the O-ring conforms with JIS B2401.

Seal Kit Number

AC SOL.		DC SOL.	
Single Solenoid	Double Solenoid	Single Solenoid	Double Solenoid
ECBS-AA	ECBS-CA	ECBS-AD	ECBS-CD

Part No.	Part Name	Part No.	Part Name
1	Body	14	Coil yoke
2	Plug	15	Terminal box kit
3	Spool	16	Nameplate
4	Retainer	17	O-ring
5	Retainer B	18	O-ring
6	Spacer	19	O-ring
7	Spring	20	O-ring
8	Nut		
9	Rod		
10	Solenoid guide		
11	Solenoid coil		
12	Packing B		
13	Coil case		