



Pressure Reducing Modular Valve

40 to 300ℓ/min
25,35MPa

Features

- ① This modular valve makes the pressure in part of the circuit lower than the main circuit.
- ② Even when pressure changes in the primary main circuit, the reduced secondary pressure is maintained at a constant level.
- ③ Maximum Operating Pressure: 25, 35MPa {255, 357kgf/cm²}

Specifications

Model No.	Nominal Diameter (Size)	Maximum Working Pressure MPa{kgf/cm ² }	Maximum Flow Rate ℓ/min	Pressure Adjustment Range MPa{kgf/cm ² }	Weight kg	Gasket Surface Dimensions
OG-G01-AC-21 A1 A2	1/8	25{255}	50	0.15 to 3.5{ 1.5 to 35.7}	1.3	ISO 4401-03-02-0-05
OG-G01-BC-21 B1 B2				0.8 to 7{ 8.2 to 71.4}		
OG-G03-AC-J51 A1 A3	3/8	25{255}	80 but C : 50	0.15 to 3.5{ 1.5 to 35.7}	1.3	
OG-G03-BC-J51 B1 B3				0.8 to 7{ 8.2 to 71.4}		
OGH-G04-A1-10 A3	1/2	35{357}	300	0.25 to 21{35.7 to 214}	3.8	ISO 4401-05-04-0-05
OGH-G04-B1-10 B3				0.25 to 3.5{ 2.5 to 35.7}		
OGH-G04-A1-10 A3	1/2	35{357}	300	0.8 to 7{ 8.2 to 71.4}	8.0	ISO 4401-07-06-0-05
OGH-G04-B1-10 B3				3.5 to 25{35.7 to 255}		
OGH-G04-A1-10 A3	1/2	35{357}	300	0.8 to 7{ 8.2 to 71.4}	8.0	ISO 4401-07-06-0-05
OGH-G04-B1-10 B3				3.5 to 25{35.7 to 255}		

● Handling

- ① When using a remote control valve in a vent circuit, certain vent circuit pipe capacities can cause vibration. Because of this, thick steel pipe with an inside diameter of $\phi 4$ mm that is no longer than three meters is recommended. Vent piping cannot be used with the 01, 03 sizes.
- ② With the 01, 03 sizes, the flow rate is limited at low pressures. See the Pressure- Flow Rate Characteristics on page D-40 and D-41 for more information.
- ③ For the 03 size, the drainage can be allowed to escape through the T port. In the case of a valve with the auxiliary symbol B, however, run a return pipe from the drain discharge port directly to the tank.
- ④ With the 04 sizes, piping is not required because drainage can be allowed to escape from the gasket side drain port. In the case of a valve with the auxiliary symbol B, however, run a return pipe from the drain discharge port directly to the tank.
- ⑤ Note that a change in drain back pressure causes a change in setting pressure.
- ⑥ Note that a sub plate and installation bolts are not included. See pages D-90 through D-95 if these items are required.
- ⑦ 04 series modular valves do not have an L (DR₂) drain port, so they cannot be used in combination with pressure center type solenoid valves (D).
- ⑧ With the 03, 04 sizes, the control port can be changed by altering the attachment orientation of the back cover. See the installation diagram for more information. After making this change, be sure also to make the other changes as in accordance with the model number indicated on the nameplate.
- ⑨ Use the P port control valve concurrently with the 01 size central all-port-block (C5) solenoid valve if when the valve is in the central position and external pressure may cause the pressure at the control port to exceed the set pressure.

Explanation of model No.

01, 03 size

OG - G 03 - B 1 - (B) - J51

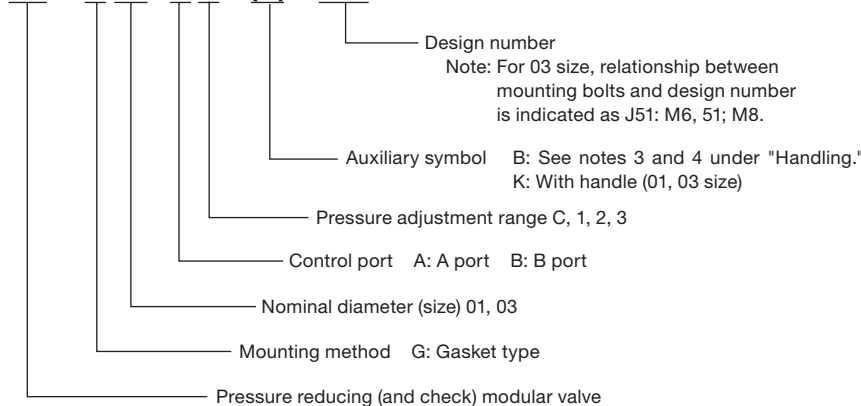

Explanation of model No.

04 size

OGH - G 04 - A 1 - (B) - 10

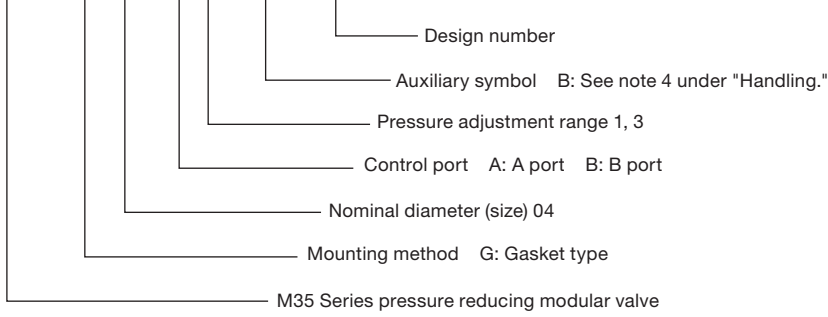

Installation Dimension Drawings

Note) Pressure is increased by clockwise (rightward) rotation of the adjusting screw (bolt), and decreased by counterclockwise (leftward) rotation.

OG-G01-A*-21

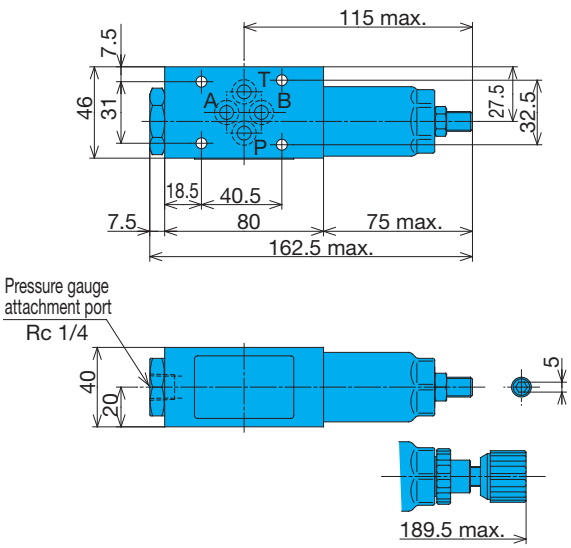

OG-G01-B*-21

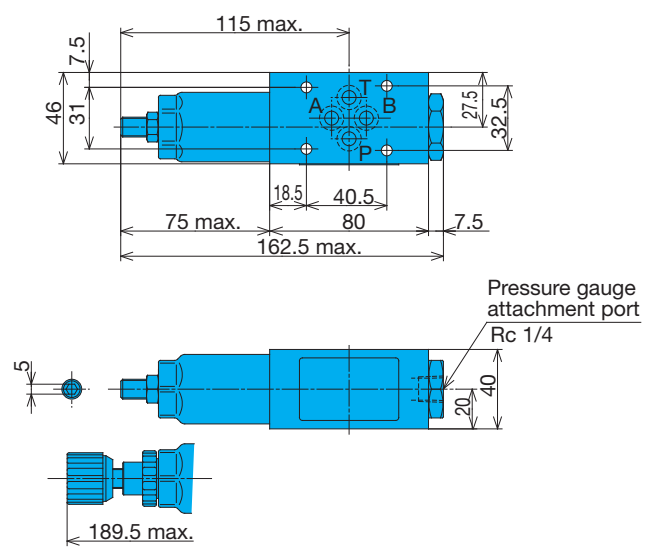

OG-G03-A*-J51

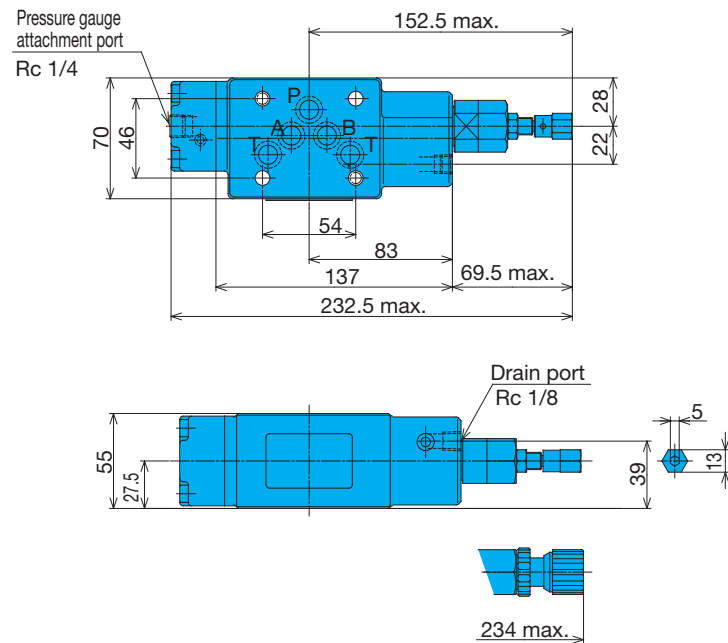

OG-G03-B*-J51

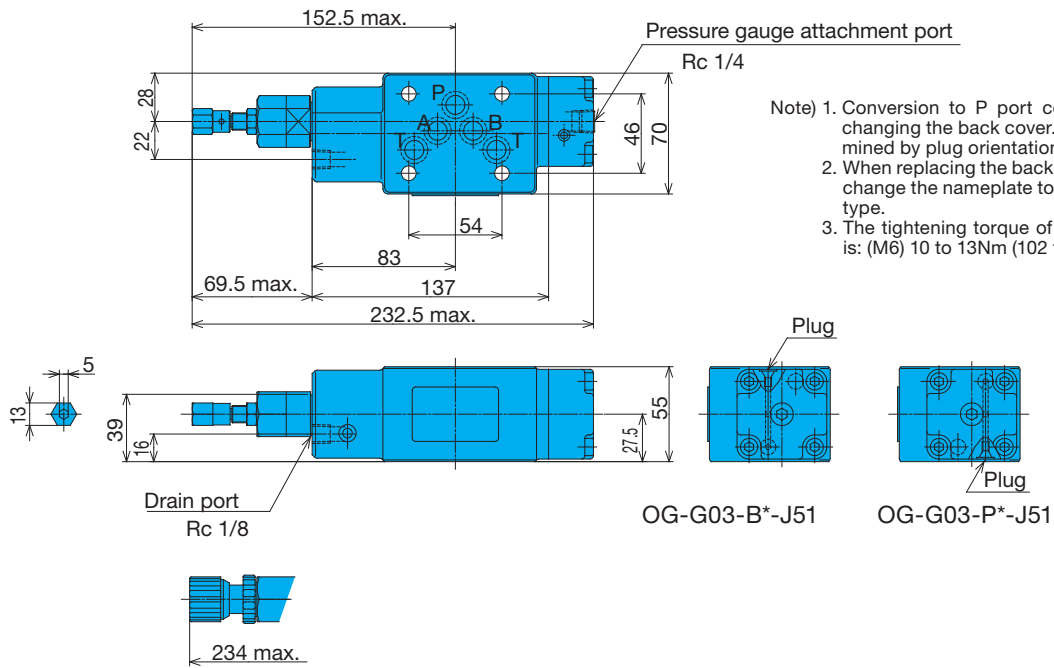

- Note) 1. Conversion to P port control is possible by changing the back cover. Port control is determined by plug orientation.
 2. When replacing the back cover, be sure also to change the nameplate to the applicable model type.
 3. The tightening torque of the back cover bolts is: (M6) 10 to 13Nm (102 to 133 kgf-cm).

OGH-G04-A*-10

- Note) 1. Conversion to P, B port control is possible by changing the back cover. Port control is determined by plug orientation.
 2. When replacing the back cover, be sure also to change the nameplate to the applicable model type.
 3. The tightening torque of the back cover bolts is: (M10) 45 to 55Nm (460 to 560 kgf-cm).

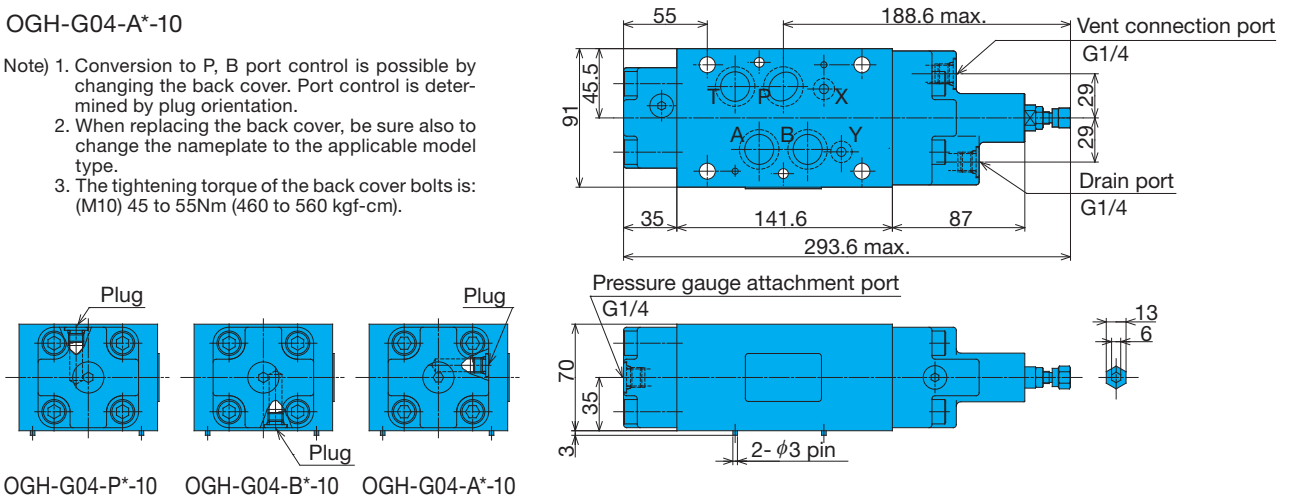

Performance Curves

Hydraulic Operating Fluid Kinematic Viscosity 32mm²/s

Pressure Loss Curve

OG-G01-B*-21

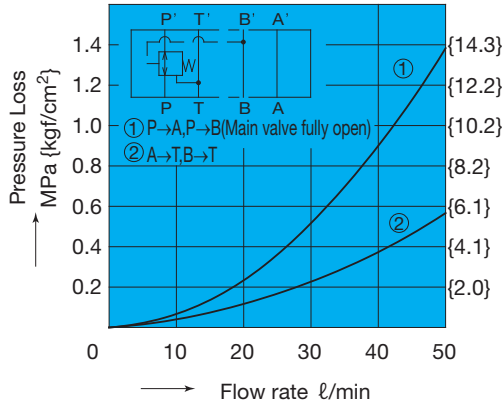

OG-G03-B*-J51

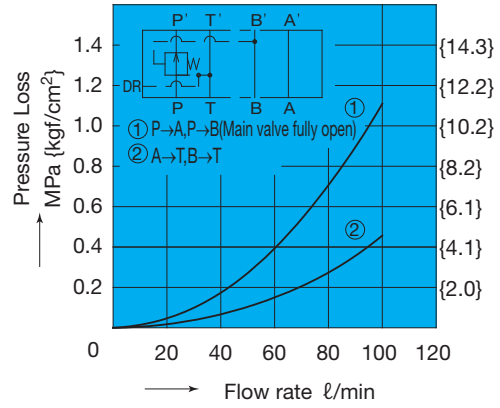

OGH-G04-**-10

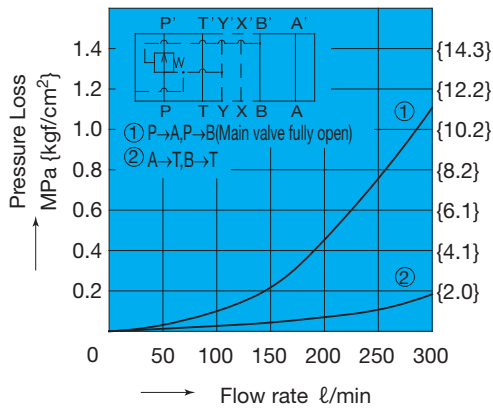

Pressure – Flow Rate Characteristics

OG-G01-B₂¹-21

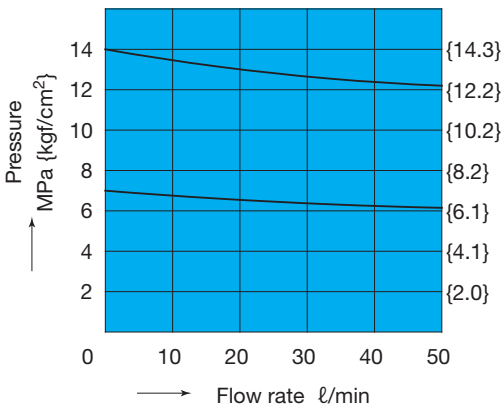

OG-G01-BC-21

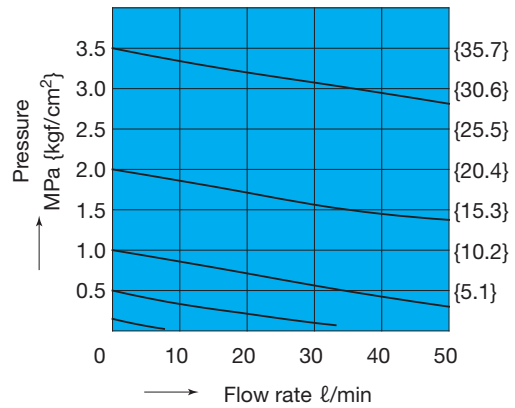

Modular Valve

OG-G03-B₃¹-J51

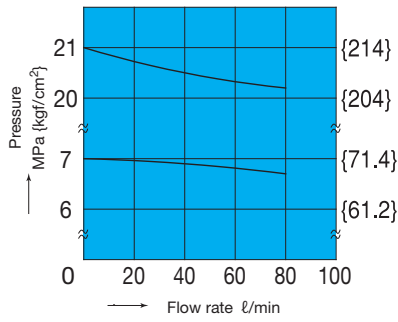

OG-G03-BC-J51

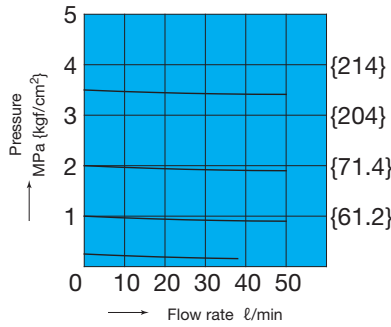

OGH-G04-**-10

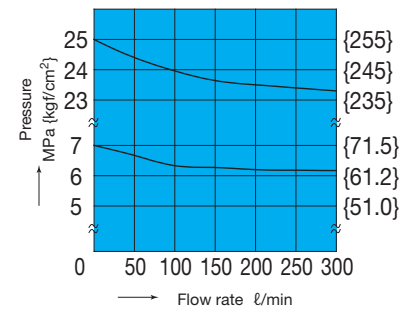

Pressure – Drain Rate Characteristics

OG-G01-B*-21

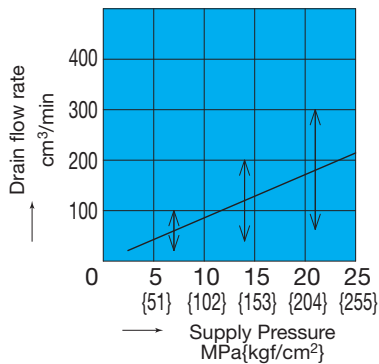

OG-G03-B*-J51

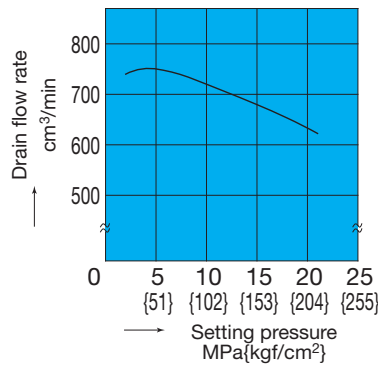

OG-G03-BC-J51

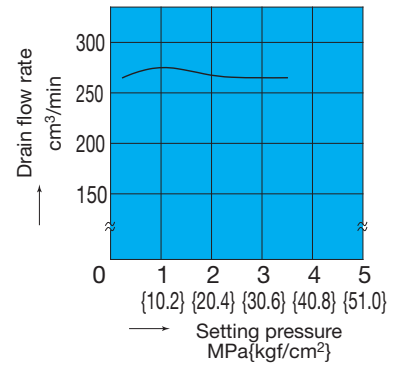

Determine it through the maximum value when designing the circuit.

OGH-G04-*3-10

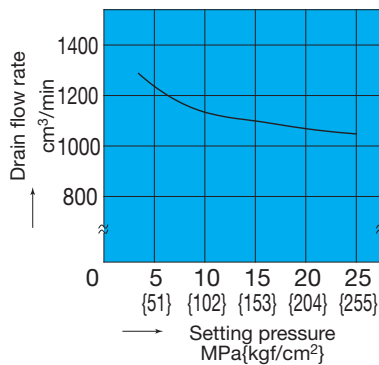

Number of Adjusting Screw Rotations – Pressure Characteristics

OG-G01-**-21

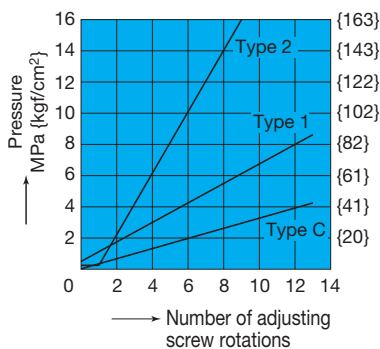

OG-G03-**-51

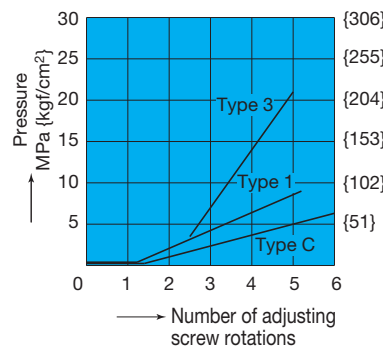

OGH-G04-**-10

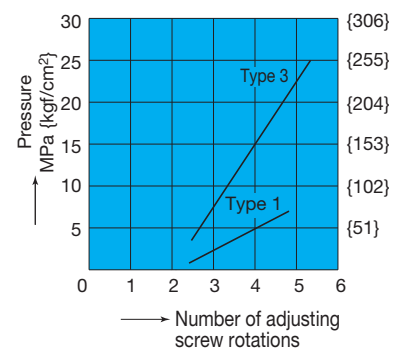

Cross-sectional Drawings

OG-G01-A2-21

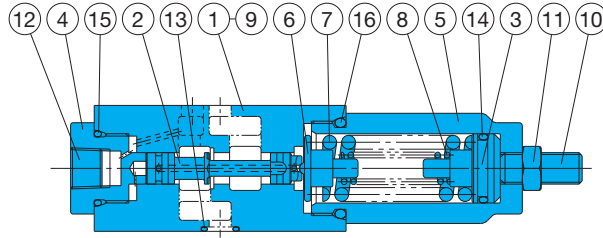

Part No.	Part Name
1	Body
2	Spool
3	Push rod
4	Bushing
5	Retainer
6	Guide
7	Spring
8	Spring
9	Plate
10	Screw
11	Nut
12	Plug
13	O-ring
14	O-ring
15	O-ring
16	O-ring
17	Knob
18	Nut
19	Screw

Seal Part List (Kit Model Number BRBS-01GP-0A)

Part No.	Part Name	Part Number	Q'ty
13	O-ring	AS568-012(NBR-90)	4
14	O-ring	NBR-70-1 P18	1
15	O-ring	NBR-90 P20	1
16	O-ring	NBR-90 P26	1

Note) The materials and hardness of the O-ring conform with JIS B2401.

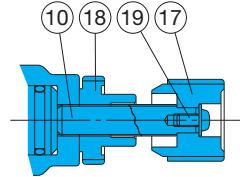

Note) Part number 8 is used in the case of pressure adjustment range type 2 only.

OG-G01-AC-21

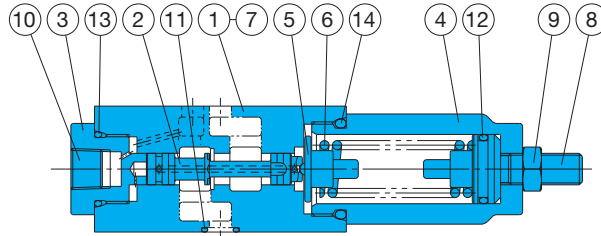

Part No.	Part Name
1	Body
2	Spool
3	Bushing
4	Retainer
5	Guide
6	Spring
7	Plate
8	Screw
9	Nut
10	Plug
11	O-ring
12	O-ring
13	O-ring
14	O-ring
15	Knob
16	Nut
17	Screw

Seal Part List (Kit Model Number BRBS-01GP-0A)

Part No.	Part Name	Part Number	Q'ty
11	O-ring	AS568-012(NBR-90)	4
12	O-ring	NBR-70-1 P18	1
13	O-ring	NBR-90 P20	1
14	O-ring	NBR-90 P26	1

Note) The materials and hardness of the O-ring conform with JIS B2401.

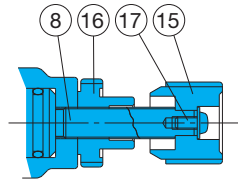

OG-G03-B*-J51

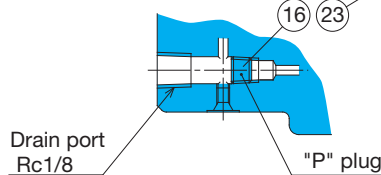
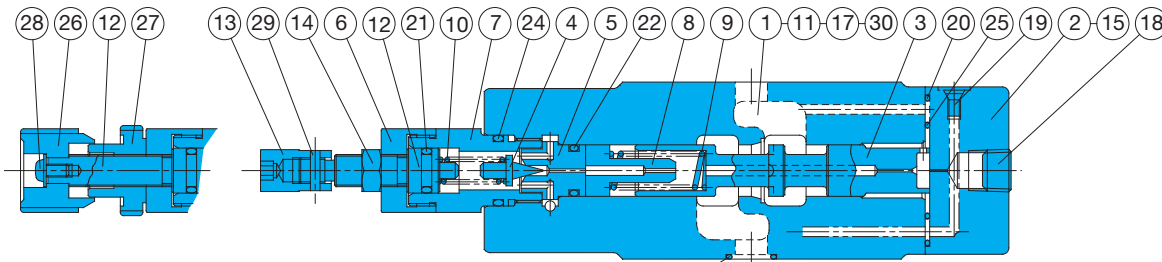

Note) The discharge port of the OG-G03-**-J51 has the plug (TPHA-1/8), the "P" plug (TPUA-1/16) is not attached. The OG-G03-**-B-J51 does not have a plug in the drain discharge port with the "P" plug attached, so pipe must be run from the drain discharge port to provide drainage.

Seal Part List (Kit Model Number BRES-03G*-1A)

Part No.	Part Name	Part Number	Q'ty	
			A	B
20	O-ring	NBR-90 P6	2	2
21	O-ring	NBR-70-1 P10A	1	1
22	O-ring	NBR-90 P12	1	1
23	O-ring	AS568-014(NBR-90)	5	5
24	O-ring	NBR-90 P18	1	1
25	O-ring	AS568-023(NBR-90)	1	1

Note) 1. The materials and hardness of the O-ring conform with JIS B2401.
2. Specify A or B for the asterisk (*) in the kit model number.

Part No.	Part Name	Part No.	Part Name	Part No.	Part Name
1	Body	11	Plate	21	O-ring
2	Cover	12	Screw	22	O-ring
3	Spool	13	Nut	23	O-ring
4	Poppet	14	Nut	24	O-ring
5	Seat	15	Screw	25	O-ring
6	Bushing	16	Plug	26	Knob
7	Retainer	17	Plug	27	Nut
8	Choke	18	Plug	28	Screw
9	Spring	19	Plug	29	Pin
10	Spring	20	O-ring	30	Pin

OG-G03-BC-J51

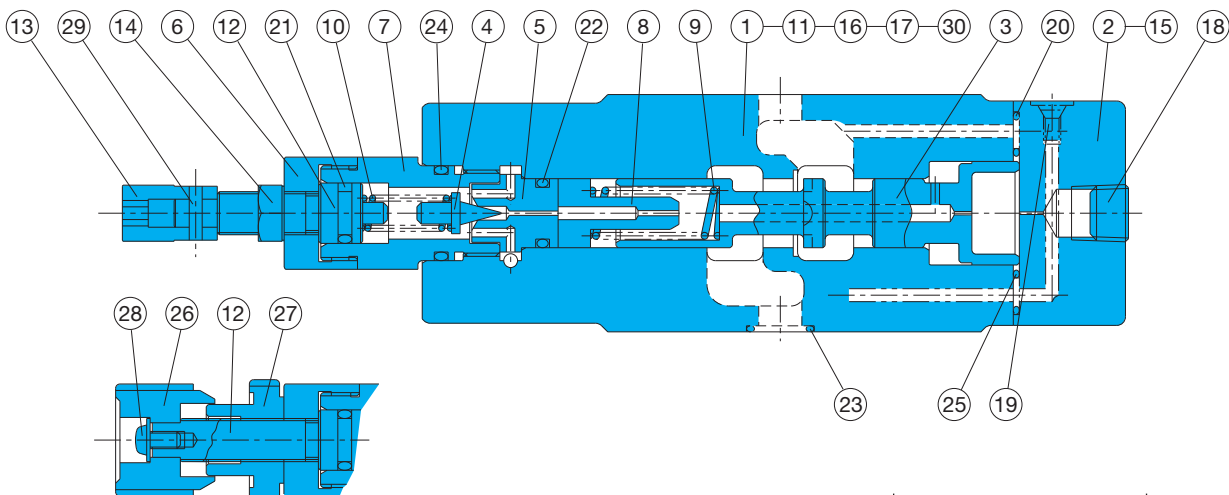

Seal Part List (Kit Model Number BRES-03GC*-1A)

Part No.	Part Name	Part Number	Q'ty	
			A	B
20	O-ring	NBR-90 P6	2	2
21	O-ring	NBR-70-1 P10A	1	1
22	O-ring	NBR-90 P12	1	1
23	O-ring	AS568-014(NBR-90)	5	5
24	O-ring	NBR-90 P18	1	1
25	O-ring	AS568-023(NBR-90)	1	1

Note) 1. The materials and hardness of the O-ring conform with JIS B2401.
 2. Specify A or B for the asterisk (*) in the kit model number.

Part No.	Part Name	Part No.	Part Name
1	Body	16	Plug
2	Cover	17	Plug
3	Spool	18	Plug
4	Poppet	19	Plug
5	Seat	20	O-ring
6	Bushing	21	O-ring
7	Retainer	22	O-ring
8	Choke	23	O-ring
9	Spring	24	O-ring
10	Spring	25	O-ring
11	Plate	26	Knob
12	Screw	27	Nut
13	Nut	28	Screw
14	Nut	29	Pin
15	Screw	30	Pin

OGH-G04-**-10

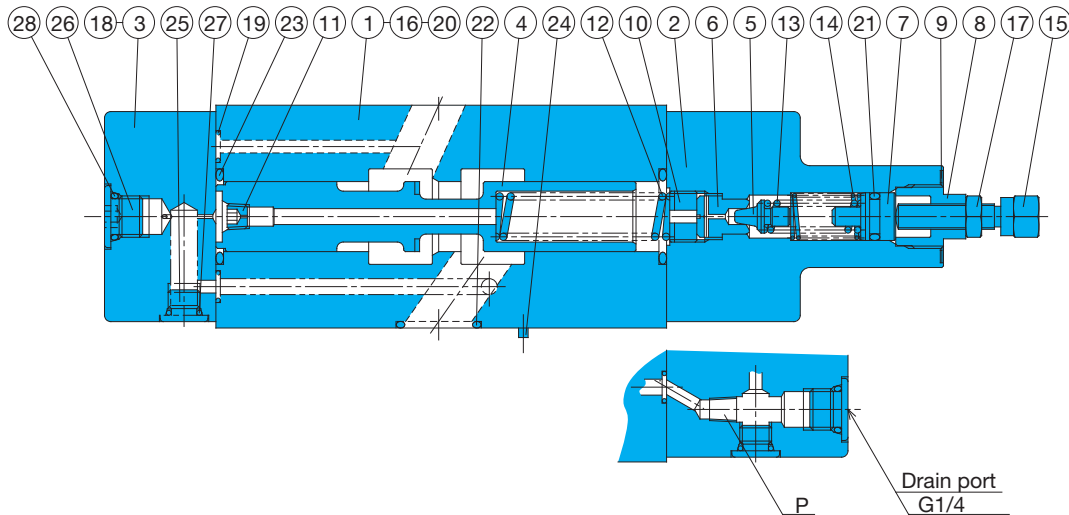

Seal Part List (Kit Model Number BRKS-04**)

Part No.	Part Name	Part Number	Q'ty	
			G	GB
19	O-ring	NBR-90 P7	4	4
20	O-ring	AS568-012(NBR-90)	2	2
21	O-ring	NBR-70-1 P11	1	1
22	O-ring	AS568-118(NBR-90)	4	4
23	O-ring	NBR-90 G25	2	2
27	O-ring	NBR-90 P8	4	4
28	O-ring	NBR-90 P11	3	2

Note) 1. The materials and hardness of the O-ring conform with JIS B2401.
 2. Specify G (internal drain) or GB (external drain) for the asterisk (*) in the kit model number.

Part No.	Part Name
1	Body
2	Cover
3	Cover
4	Spool
5	Poppet
6	Seat
7	Plunger
8	Retainer
9	Plate
10	Collar
11	Choke
12	Spring
13	Spring
14	Spring
15	Screw
16	Plate
17	Nut
18	Screw
19	O-ring
20	O-ring
21	O-ring
22	O-ring
23	O-ring
24	Pin
25	Plug
26	Plug
27	O-ring
28	O-ring

Note) In the standard configuration, OGH-G04-**-10 does not require a P plug, while OGH-G04-**-B-10 requires a P plug (TPUA-1/16) and drain pipe from the cover.