

CLOSED POSITION

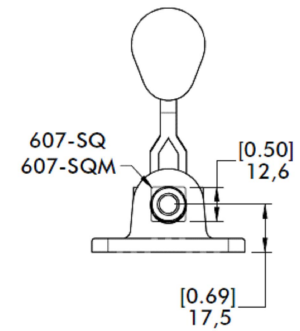

NOTES :

1. MAX. HOLDING CAPACITY : [800 lbf] 3560 N
2. WEIGHT : [1.63 lb] 0,74 kg
3. PLUNGER TRAVEL : [1.63] 41,4
4. PLUNGER THREAD (M) : M8
5. REFER CATALOG PAGE FOR MORE DETAILS
6. DIMENSIONS AND TOLERANCES SUBJECT TO CHANGE WITHOUT PRIOR NOTICE

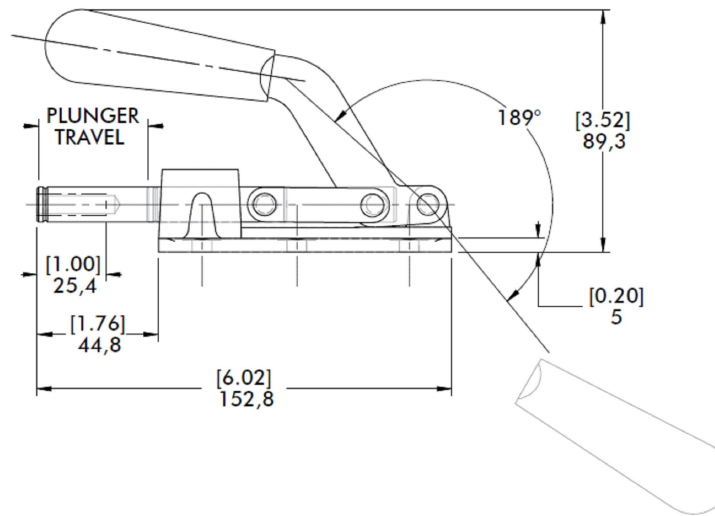
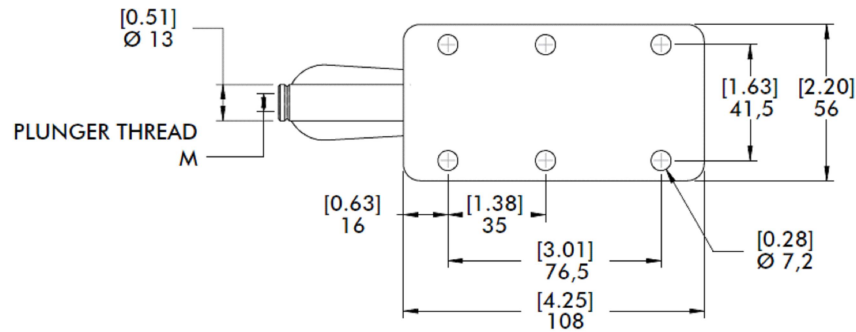
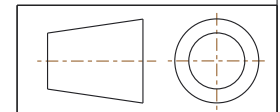

COMPONENT	Straight Line Action Clamps	
DIMENSIONS : [IN] MM	607-M	REV
TOLERANCES : ±[0.020] 0.51		06/04/19
	607-SERIES	SHEET
		1 of 1



15 Corporate Drive,
Auburn Hills, MI 48326, USA
Phone: 888-337-8226, Fax: 800-682-9689
www.destaco.com

This Drawing is the Property of DESTACO.
It contains confidential, proprietary
information that is DESTACO property. Do
not disclose to or duplicate for others
except as authorized by DESTACO.