

CLOSED POSITION

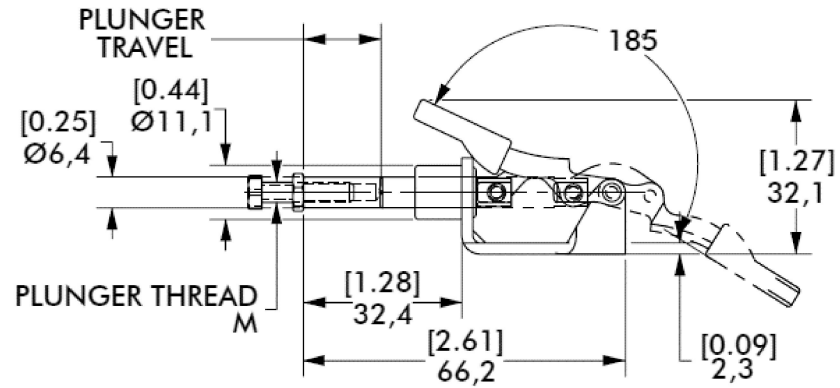

NOTES :

1. MAX. HOLDING CAPACITY : [100 lbf] 440 N
2. WEIGHT : [0.09 lb] 0,04 kg
3. PLUNGER TRAVEL : [0.63] 16
4. PLUNGER THREAD (M) : M4
5. SPINDLE INCLUDED : NO
6. DIMENSIONS AND TOLERANCES SUBJECT TO CHANGE WITHOUT PRIOR NOTICE

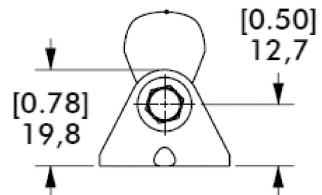
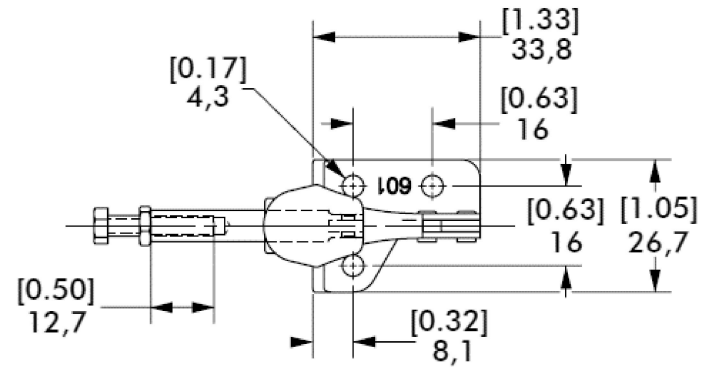
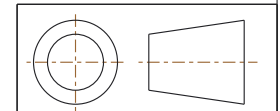

COMPONENT	Straight Line Action Clamps	
DIMENSIONS : [IN] MM	601-M	REV
TOLERANCES : ±[0.020] 0.51		03/15/19
	601-SERIES	SHEET
		1 of 1



15 Corporate Drive,
Auburn Hills, MI 48326, USA
Phone: 888-337-8226, Fax: 800-682-9689
www.destaco.com

This Drawing is the Property of DESTACO.
It contains confidential, proprietary
information that is DESTACO property. Do
not disclose to or duplicate for others
except as authorized by DESTACO.