

CLOSED POSITION

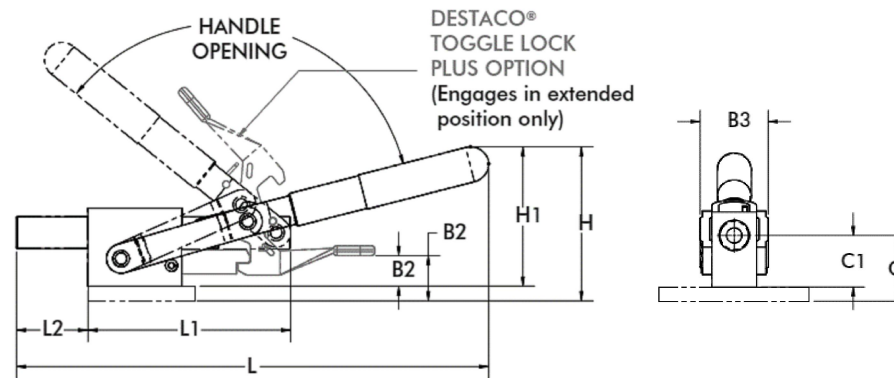

A	28,6 [1.13]	D	8,6 [0.34]
A1	44 [1.73]	D1	13 [0.51]
A3	7,7 [0.30]	H	63,1 [2.49]
B	47,6 [1.87]	H1	57,1 [2.25]
B1	64 [2.52]	L	193,4 [7.61]
B2	18,5 [0.73]	L1	83 [3.27]
B3	29 [1.14]	L2	29,3 [1.15]
C	28 [1.10]	M	M8
C1	22 [0.87]	-	-

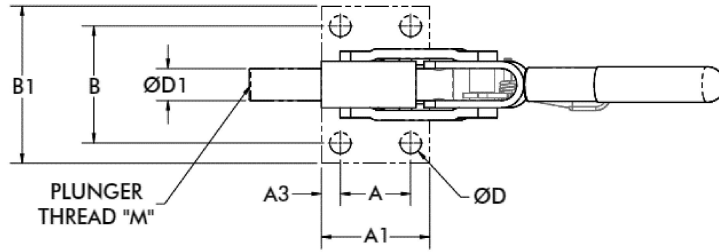
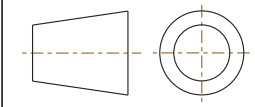

**NOTES :**

1. MAX. HOLDING CAPACITY : [2500 lbf] 11120 N
2. WEIGHT : [1.15 lbs] 0,52 kg
3. PLUNGER TRAVEL : [1.00] 25,4
4. HANDLE OPENING : 113°
5. DIMENSIONS AND TOLERANCES SUBJECT TO CHANGE WITHOUT PRIOR NOTICE



15 Corporate Drive,  
Auburn Hills, MI 48326, USA  
Phone: 888-337-8226, Fax: 800-682-9689  
www.destaco.com

This Drawing is the Property of DESTACO.  
It contains confidential, proprietary  
information that is DESTACO property. Do  
not disclose to or duplicate for others  
except as authorized by DESTACO.

**COMPONENT**

Heavy-Duty Straight Line Action Clamps

DIMENSIONS : [IN] MM

**5131-MR**

**REV**

03/14/19

TOLERANCES : ±[0.020] 0.51

**5131-SERIES**

**SHEET**

1 of 1